

USER MANUAL

**AT**

SHAFT ALIGNMENT



**acoem**

CREATING ENVIRONMENTS OF POSSIBILITY



## CONTENT

Welcome to our world	1.1
Declaration of Conformity	2.1
Safety	3.1
Care	4.1
Apps	5.1
Shaft Alignment Horizontal Machines	6.1
Shaft Alignment Vertical Machines	7.1
Pre-Alignment	8.1
Flatness Measurement	9.1
Sensors M7 and S7	10.1
Sensors M10 and S10	11.1
Sensors M9 and S9	12.1
Run-Out Probe P1	13.1
Laser Transmitter T21	14.1

ACOEM Home - Launcher	15.1
Flir One	16.1
Technical Specification M7 and S7	17.1
Technical Specification M10 and S10	18.1
Technical Specification M9 and S9	19.1
Technical Specification P1	20.1
Technical Specification T21	21.1

User Manual AT is general for AT systems. Available equipment, apps and functions depend upon which system you have selected.



## **WELCOME TO OUR WORLD**

*For almost 40 years, ACOEM has helped industries throughout the world to achieve more profitable and sustainable production. We have reached where we are today by having the courage to think beyond the norm and follow slightly unconventional paths. We have had the courage to make mistakes and find new directions. Through our resolve, ambition, and knowledge we have become a global player and a leader in innovative, user-friendly reliability solutions.*

## **SUSTAINABLE INNOVATIONS**

During our almost 40 years in this industry, we have explored, tweaked, and tested more than anyone. Some might say we are incurable innovators whereas others might say that we are highly focused. They both probably have a point. If we had not been devoted and ambitious, we would not have

been the first in the field of laser alignment to have a touch screen. Nor would we have been pioneers in the use of visible lasers and dual measurement heads. Nor would we have been the first to bring a wireless vibration sensor for machine diagnostics. We are now the first to provide a combined alignment and diagnostic solution on standard mobile devices.

Over the years, we have learnt to never compromise on quality, and we are constantly in search of new, unexplored opportunities by combining advanced technology with design and function. By doing so, we have become the leading innovator in our industry. Not only do we minimize wear, production stoppages and costs, but we also help save the environment. Natural resources are in short supply and if we can contribute to a more sustainable world by making it a little bit straighter, we could not be happier.

## **TRUE COMMITMENT**

One reason for our success is our solid commitment. We have ensured that we remain attentive to constantly picking up on the needs of the market. Our expert employees and dedicated dealers in over 70 countries are undoubtedly our most important asset. Satisfaction and team spirit are of particular importance to us and are consistently at the top of our priority list. With experience from a wide range of industries and manufacturing processes, we are fully aware of the problems and needs of our end-customers. We are passionate about what we do, and we are driven by the desire to eliminate anything in the industry worldwide that may be even slightly out of line.

## **PURE USABILITY**

Our design and user-friendliness are carefully interwoven. As we develop new products, they also become cleaner, smarter, more functional, and more robust. An industrial environment is demanding, infinitely more difficult to work in and inevitably subject to time pressure. There is no place for equipment with unnecessary functions, complicated interfaces and that is difficult to assemble.

Usability and user friendliness mean everything, not only to us but also to our customers. We have designed products that are easy to learn and can be incorporated quickly. By removing non-essential functions, we make life less difficult for our users – and probably a little more difficult for our competitors.

## **END USER LICENSE AGREEMENT**

The rights to use the software in this product are offered only on the conditions that you agree to all the terms stated below, i.e., the end user agreement. By using this product, you agree to be bound by this agreement. If you do not accept this agreement your sole remedy is to return the entire unused product, hardware, and software, promptly to your place of purchase for a refund.

The user is granted a single license to use the software contained in this product. Use is only permitted on the hardware it has been installed on at the time of purchase. The software may not be removed from the hardware. The software contained in the system is the property of ACOEM group, any copying or redistribution is strictly prohibited.

Modifying, disassembling, reverse engineering or decompiling the system or any part thereof is strictly prohibited.

Disclaimer of warranties: To the maximum extent permitted by applicable law, ACOEM and its suppliers provide the software contained in this product 'as is' and with all faults, and hereby disclaim all other warranties either expressed, implied or statutory.

Limited liability: No liability shall exceed the price of the product, and the sole remedy, if any, to any claim shall be a right of return and refund.

ACOEM or its suppliers shall, to the maximum extent permitted by applicable law, not be liable for any indirect, special, incidental, punitive, and consequential damages arising from the use of the system or any part thereof, authorized, or unauthorized.

ACOEM group is headquartered in Lyon, France. For more information, please visit [acoem.com](http://acoem.com)





## **DECLARATION OF CONFORMITY**

In accordance with  
2014/35/EU Low Voltage Directive  
2014/53/EU Radio Equipment Directive  
2012/19/EC Waste electrical and electronic  
equipment (WEEE)  
2011/65/EU Restriction of the use of certain  
hazardous substances (RoHS)  
2006/66/EU Battery Directive  
2001/95/EC CE marking directive

### **Type of equipment**

Alignment Tool

### **Brand name or trademark**

ACOEM

### **Type designation(s)/Model no(s)**

1-1216 M7  
1-1217 S7  
1-1278 M10  
1-1279 S10  
1-1263 M9  
1-1264 S9  
1-0897 T21  
1-1063 P1

### **Manufacturer's name, address, telephone & fax no**

ACOEM AB  
Box 7  
SE-431 21 Mölndal  
Sweden

Tel: +46 31 7062800  
Fax: +46 31 7062850

The following standards and/or technical specifications, which comply with good engineering practice in safety matters in force within the EEA, have been applied:

**Standard/Test report/Technical construction file/Normative document**

EN 61000-6-3:2007.

EN 61000-6-2:2005, EN 61000-4-2, -3, -4, -5, -6, -11.

EN 61010-1:2010

ISO9001:2015 Ref. No/ Issued by: DNV Certification AB Certification No. 2009-SKM-AQ-2704/2009-SKM-AE-1419.

The laser is classified in accordance with the International Standard IEC-60825-1:2014, USA FDA Standard 21 CFR, Ch 1, Part 1040.10 and 1040.11 except for deviations pursuant to laser notice No. 50, dated June 24, 2007.

The wireless device complies with Part 15 of the FCC Rules. Operation is subject to the following two conditions;

(1) this device may not cause harmful interference, and

(2) this device must accept any interference received, including interference that may cause undesired operation.

**Additional information**

The product was CE-marked in 2023.

As manufacturer, we declare under our sole responsibility that the equipment follows the provisions of the Directives stated above.

**Date and place of issue**

Mölnadal 2023-05-30

**Signature of authorized person**A handwritten signature in black ink, appearing to read 'Hans Svensson', written in a cursive style.

Hans Svensson, Managing Director



## **SAFETY**

Retain and follow all product safety and operating instructions. Observe all warnings on the product and in the operating instructions.

Failure to observe the safety pre-cautions and operating instructions can cause bodily injury, fire, and damage to the equipment.

Do not disassemble, modify, or use the equipment in other ways than explained in the operating instructions. ACOEM AB will not accept any liability for such use.



## **WARNING!**

Do not mount equipment on running machines and take all appropriate measures to prevent unintentional start-up of machines. Make sure to fully comply with all appropriate shut down procedures, safety measures and regulations at worksite and local regulations regarding safety in a machine environment.

## LASER PRECAUTIONS

The system uses laser diodes with a power output of  $< 1.0$  mW. The laser classification is Class 2.

Class 2 is considered safe for its intended use with only minor precautions required. These are:

- Never stare directly into the laser transmitter.
- Never shine the laser directly into anyone else's eyes.



COMPLIES WITH 21 CFR 1040.10 AND 1040.11  
EXCEPT FOR DEVIATIONS PURSUANT TO  
LASER NOTICE No. 50, DATED JUNE 24, 2007



### CAUTION!

USE OF CONTROLS OR  
ADJUSTMENTS OR  
PERFORMANCE OF  
PROCEDURES OTHER THAN  
THOSE SPECIFIED HEREIN  
MAY RESULT IN HAZARDOUS  
RADIATION EXPOSURE.

Your system complies with the requirements in:

- IEC-60825-1:2007
- British Standard BS EN 60825-1
- DIN EN 60825-1
- USA FDA Standard 21 CFR, Ch 1, Part 1040.10 and 1040.11

## POWER SUPPLY

The sensors are powered by high-capacity rechargeable Li-Ion batteries mounted in the sensors or by the external power unit.



The sensors can be connected to their charger and charged while lying in the case. It is important that the lid of the case is open during the charging and that the charger is placed outside the case or else the system will not be charged properly and might be damaged.

Do not expose the power adapter to rain or wet conditions.

Always unplug the charger from the electrical outlet after charging.

Leaving a display unit or a measurement unit with an empty battery for a prolonged time can reduce the capacity of the battery or even damage the battery.

If the system is not used for a long time, charge the batteries to approximately 50-75% before storing the system, if kept in storage repeat this every 3-4 month (if needed).

When used in typical conditions the battery will sustain good capacity for approximately 2-3 years before needing replacement. Contact your sales representative for battery replacement.

The batteries contain safety circuitry to operate safely with the display unit. The unit can therefore only be used with the Li-Ion batteries supplied by ACOEM.

Improper replacement of batteries can cause damage and risk for personal injury.





## **WARNING!**

BATTERY REPLACEMENT SHALL ONLY BE PERFORMED BY AUTHORIZED ACOEM REPRESENTATIVES.

USE OF ANY OTHER BATTERIES THAN THOSE SUPPLIED BY ACOEM WILL CAUSE SEVERE DAMAGE TO THE SENSOR AND CAN CAUSE RISK FOR PERSONAL INJURY!

Handle any batteries with care. Batteries pose a burn hazard if handled improperly. Do not disassemble and keep away from heat sources. Handle damaged or leaking batteries with extreme care. Please keep in mind that batteries can harm the environment. Dispose of batteries in accordance with local regulatory guidelines, if in doubt contact your local sales representative.

Only use the external power adapters supplied by ACOEM for use with the sensors. Using other power adapters can cause damage to the unit and personal injury.

## WIRELESS TRANSCEIVER

The sensors are fitted with Bluetooth wireless transceivers.

Make sure that there are no restrictions on the use of radio transceivers at the site of operation before using the wireless transceivers.



### **WARNING!**

Before using the wireless transceivers make sure that there are no restrictions on the use of radio transceivers at the site. Do not use on aircraft.

# CARE

## PACKING THE CASE



Example AT-200

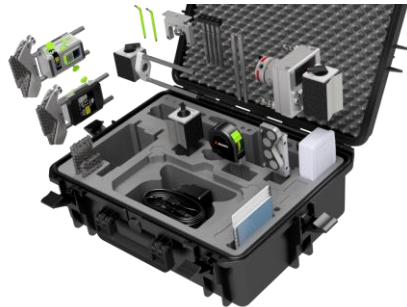

Example AT-400 Ultimate

## CLEANING

The system should be cleaned with a cotton cloth, or a cotton bud moistened with a mild soap solution, except for the detector and laser window surfaces, which should be cleaned with alcohol.

For the best possible function, the laser diode apertures, detector surfaces and connector terminals should be kept free from grease or dirt.



Do not use paper tissue, which can scratch the detector surface.



Do not use acetone.

The chains on the V-brackets are delivered dry. If the system is used in highly corrosive environments, the chains should be oiled.

## **DATE OF CALIBRATION DISCREPANCY**

Our instruments store the electronic date of the latest calibration of the instrument. Due to production processes and storage time, this date will differ from the date of the calibration certificate. Hence, it is the date of the calibration certificate which is important and that indicates when the next calibration is due.



## APPS

The following apps can be available in the AT system.



Horizontal Shaft Alignment



Vertical Shaft Alignment



Pre-Alignment



Flatness Measurement

Download the apps from Google Play or App Store.

The Horizontal Shaft Alignment app and the Vertical Shaft Alignment app work with the sensors M7 & S7, M10 & S10 and M9 & S9.

The Pre-Alignment app works with the Run-Out probe P1, and the sensors M7 & S7, M10 & S10 and M9 & S9.

The Flatness Measurement app works with the sensor M9.

Available apps and functions depend upon which system you have selected.









## **SHAFT ALIGNMENT HORIZONTAL MACHINES**

### **INTRODUCTION**

Shaft alignment: Determine and adjust the relative position of two machines that are connected, such as a motor and a pump, so that the rotational centers of the shafts are collinear, when the machines are working in a normal operating condition. Correction of horizontal shaft alignment is done by moving the front and the rear pair of one machine's feet, vertically and horizontally, until the shafts are aligned within the given tolerances. A tolerance table is available in the system.

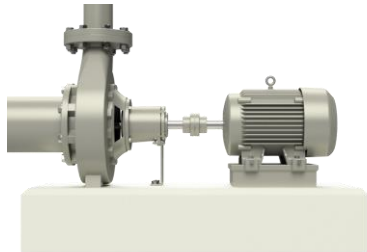

The system has two measuring units that are placed on each shaft by using the fixtures supplied with the system.

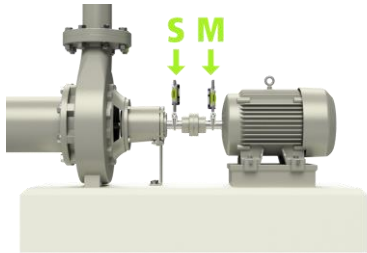

After rotating the shafts into different measuring positions, the system calculates the relative distance between the two shafts in two planes. The distances between the two measuring planes, distance to the coupling and distances to the machine feet are entered into the system. The display box then shows the actual alignment condition together with the position of the feet. Adjustment of the machine can be made directly, according to the displayed values.

The alignment results can be saved for further documentation purposes.

## PRE-ALIGNMENT FUNCTIONS

To obtain the best possible conditions for shaft alignment, it is necessary to perform some pre-alignment checks. In many cases it is necessary to make these checks to obtain precise alignment. It is often impossible to reach the desired alignment results if you do not make any pre-alignment checks.

Before going on site, check the following:

- What are the required tolerances?
- Any offsets for dynamic movements?
- Are there any restrictions for mounting the measuring system?
- Is it possible to rotate the shafts?
- What shim size is needed?

Before setting up the alignment system on the machine, check the machine foundation, bolt, and shim condition. Also check if there are any restrictions in adjusting the machine (if e.g., there is enough space to move the machine).

After the visual checks have been performed, there are some conditions that must be considered:

- Check that the machine has the right temperature for alignment.
- Take away old rusty shims (check that you can remove shims).
- Check coupling assembly and loosen the coupling bolts.
- Check soft foot conditions.
- Mechanical looseness.
- Check coupling and shaft run-out.

- Pipe work strain.
- Coarse alignment.
- Check coupling gap (axial alignment).

The Pre-Alignment app can be used for several Pre-Alignment checks.

There is also a Softcheck function in the Horizontal Shaft Alignment app.

## STARTING

Turn on the sensors.

Turn on the tablet.



Start the Horizontal Shaft Alignment app.

The Horizontal Shaft Alignment app works with the sensors M7 & S7, M10 & S10 and M9 & S9.

Go to settings for connecting the sensors if they are not already connected.



Settings.

Settings are described at the end of the chapter.

## SENSOR DEPENDENT FUNCTIONS

Some functions work only with the sensors M10 & S10 and/or M9 & S9. These functions are marked with a sensor 10 and/or sensor 9 symbol.



Require M10 & S10\*.



Require M9 & S9.

\*) M7 & S7 with Smart key work as M10 & S10.

## MOUNTING

The sensor marked "M" should be mounted on the movable machine and the sensor marked "S" on the stationary machine. The sensors shall be assembled on their V-bracket and placed front to front on each side of the coupling.

Hold the V-bracket upright and mount it on the shafts of the measurement object.



Lift the open end of the chain, tension it so that the slack is removed and attach it to the hook.



Firmly tighten the chain with the tensioning screw. Use the supplied tensioning tool. Do not overtighten. If the shaft diameter is too large the chains can be extended with extension chains.

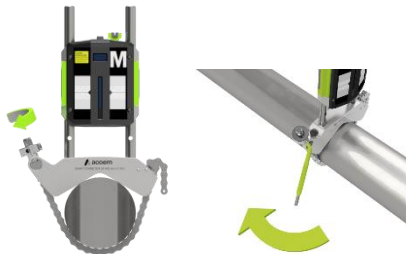

### **Adjust height M7 & S7 / M10 & S10**

Adjust the height of the sensor by sliding it on the posts until a line of sight is obtained for both lasers. Secure its position by locking both clamping devices on the back of both units.



## Adjust height M9 & S9

Adjust the height of the sensor by sliding it on the posts until a line of sight is obtained for both lasers. Secure its position with the green knobs.





## MACHINE CONFIGURATION

The screen displays the movable machine.

The traffic lights show green when the laser hits the detector.

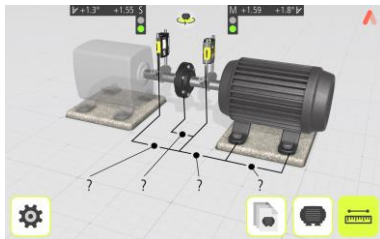

The sensor values can be enlarged by touching them.

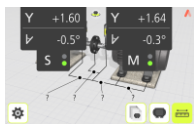

Select to enter distances and tolerances or select a pre-defined machine or work order from the machine list.



Touch the distance icon, to enter distances and tolerance.



Touch the machine list icon, to select a pre-defined machine or work order.

It is also possible to go to the configuration screen, to configure the machine.



Go to the configuration screen.

## Measure and enter distances

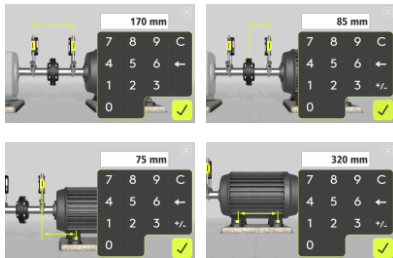

You must enter all the distances. The distance between the sensors, the distance between the center of the coupling and the M-sensor, the distance between the M-sensor and the first pair of feet and the distance between the first and the second pairs of feet.

## Enter tolerances

Alignment tolerances depend to a large extent on the rotation speed of the shafts. Machine alignment should be carried out within the manufacturer's tolerances.

The provided table can be helpful if no tolerances are specified. It is also possible to enter customized tolerances.

The tolerances are the maximum allowed deviation from desired values.

	rpm	± mm/100	± mm
<input type="checkbox"/>	0-2000	0.08	0.10
<input checked="" type="checkbox"/>	2000-3000	0.07	0.07
<input type="checkbox"/>	3000-4000	0.06	0.05
<input type="checkbox"/>	4000-6000	0.05	0.03

At the bottom right of the table, there are two icons: a pencil icon and a green checkmark icon.

Tolerance Table mm-mode

	rpm	+/- mils/100	+/- mils
<input type="checkbox"/>	3600	0.5	2.0
<input type="checkbox"/>	1800	0.7	4.0
<input checked="" type="checkbox"/>	1200	1.0	6.0
<input type="checkbox"/>	900	1.5	8.0

Tolerance Table inch-mode

	rpm	+/- mm/100	+/- mm
<input type="checkbox"/>	0-2000	0.08	0.10
<input checked="" type="checkbox"/>	2000-3000	0.07	0.07
<input type="checkbox"/>	3000-4000	0.06	0.05
<input type="checkbox"/>	4000-6000	0.05	0.03
<input type="checkbox"/>	?	?	?

Editing mode for customized tolerances



Select the tolerance to use in the alignment by touching its check box to the left.



Confirm.



Touch the edit icon to enter and edit customized tolerances.

## MACHINE LIST

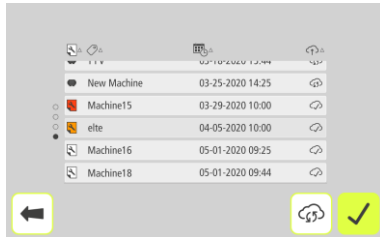

	111	03-10-2020 13:44	
	New Machine	03-25-2020 14:25	
○	Machine15	03-29-2020 10:00	
○	elite	04-05-2020 10:00	
●	Machine16	05-01-2020 09:25	
	Machine18	05-01-2020 09:44	

the list, click on the work order column header.

The machine list shows pre-defined machines and work orders.

Work orders require connection to the ACOEM Augmented Mechanics Platform. (See Settings and Cloud Synchronization at the end of this chapter.)

It is possible to order the machine list depending on each column's status by touching the column header.

For example: To bring all overdue work orders that must be managed urgently to the top of 6.12

## Pre-defined machines

Pre-defined machines can be created in the configuration screen.

A pre-defined machine is shown with a machine symbol, machine name and creation date.

Touch a machine to expand the view and show more details.



Confirm to measure the selected machine.

Other options in the expanded view.



PDF report.



Delete the machine.



Upload to cloud.

## Work orders

A work order is shown with a work order status symbol, machine name and due date.

Touch a work order to expand the view and show more details.

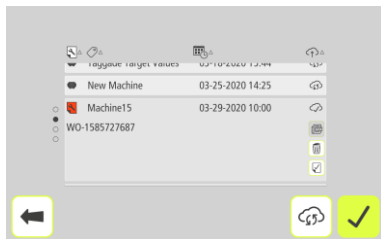

Confirm to measure the selected work order.

Other options in the expanded view.



PDF report.



Delete the work order.



Close the work order.



Upload to cloud.

### Work order status



Work order to realize,  
not started.



Work order soon overdue  
(<1 week).



Work order closed.



Work order overdue.

### Cloud sync status



Waiting to be synced.



Synced.



Not connected to cloud.

## CONFIGURATION SCREEN

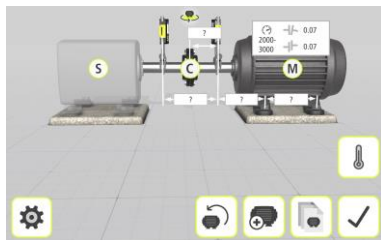

### Distances



Opens window for entering distance.

### Tolerance table

		0.07
2000-3000		0.07

Opens the tolerance table.

### Target Values



Opens Target Values.

### Add New Machine



Adds the pre-defined machine to the machine list.

### Machine List



Opens the machine list.

### Restart



Deletes all entered data and restarts the app.



## Coupling



Select coupling type.

Standard coupling or spacer shaft and coupling gap on/off.

## Confirm



Confirms the machine configuration.

## Motor



Select motor color.

Grey, blue, green, yellow, or red.

## Stationary machine



Select stationary machine type.

Alternator, blower, centrifugal compressor, fan, gear box, lobe compressor, pump or undefined machine.

## SOFTCHECK™



Go to Softcheck for checking soft foot conditions.

A soft foot condition needs to be corrected before any alignment takes place. If not, the measurement result will be of no value. It is more or less impossible to establish if there is a soft foot condition without using some kind of measurement tool. The Softcheck application checks each foot and displays the result in mm or mils.

Place the sensors at the 12 o'clock position.

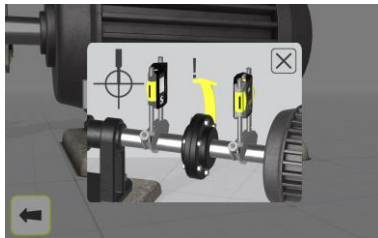

All the distances must be entered, before checking for soft foot.

Check that all foot bolts are firmly tightened.

## Measurement value registration

The application will guide you to the feet.

The first foot.



1. Loosen the bolt fully and wait a few seconds.
2. Tighten the bolt firmly, preferably with a torque wrench.
3. Register the measurement value.



Touch the confirmation icon.

Repeat the procedure at the rest of the feet.



## Measurement result and Corrections

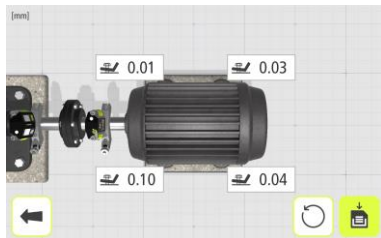

Make the necessary corrections and then check each foot again (the values show approximately how many shims that are needed to eliminate the soft foot).

Re-measurements can be done by touching the re-measure icon to re-measure all feet, or by touching a single foot to re-measure just that foot.



Re-measure all feet.



Re-measure a single foot.

The Softcheck result can be saved separately.



Touch the save icon to save the result.

(The measurement is saved in the app and can be handled further by generating a PDF report.)

## TARGET VALUES



Go to Target Values to enter target values.

(Target Values are reached from the configuration screen.)

### Introduction

Most machines develop a certain amount of heat while running. In the best case both the driving and the driven machine are affected equally requiring no input of compensation values. But in some applications the driven machine is either hotter, i.e., a pump for hot liquid, or cooler than the driving machine.

Machine manufacturers define the thermal expansion of machines differently, but in most cases, you will find it as a factor of deliberate misalignment expressed in parallel offset and angular error.

You can pre-set target values before starting your alignment work. Accepted values are feet values and angle and offset values.

The entered values are target values. Target values mean that these are the values at which the machine should be positioned when not running (cold condition) to obtain correct alignment while the machine is running (hot condition).

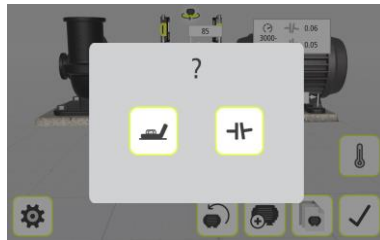

Select one of two ways to express the offset values: Feet values or angle and offset values.

## Feet values

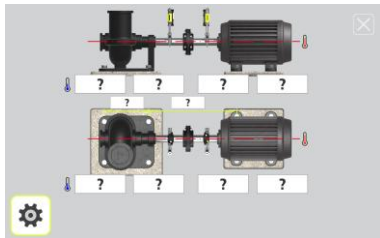

Touch the feet value boxes. Enter target values for the feet in mm or mils according to the pre-set measurement unit together with the required distances.

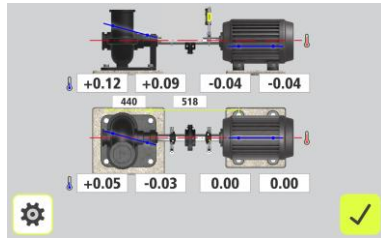

In the example above, the stationary machine will shrink vertically by 0.12 mm at the rear feet and 0.09 mm at front feet while the movable machine will expand 0.04 mm while running.

Horizontally, the rear feet will move 0.05 mm towards you and the front feet will move 0.03 mm away from you while the movable machine does not change its position while running.

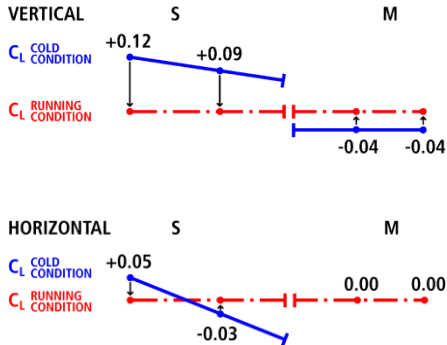

After having entered these feet values, the system calculates how the movable machine should be positioned (target position) in cold condition to obtain perfect alignment during running condition.

## Angle and offset values

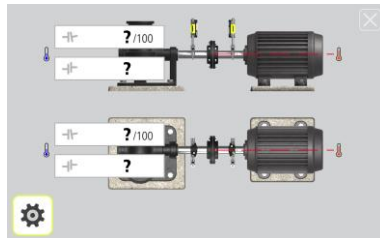

Touch the value boxes and enter target values for the angles in mm/100 mm and target values for the offsets in mm, or mils/inch and mils, according to the pre-set measurement unit.

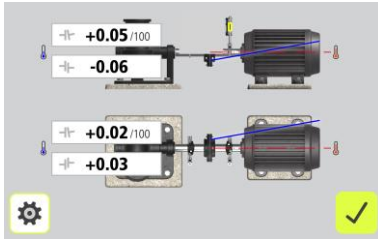

In the example above, the movable machine should be vertically adjusted to a position with an angular misalignment of  $+0.05$  mm/100 mm and an offset of  $-0.06$  mm.

Horizontally, the movable machine should be positioned with a  $+0.02$  mm/100 mm angular misalignment and a  $+0.03$  mm offset, in cold condition to obtain perfect alignment while running.

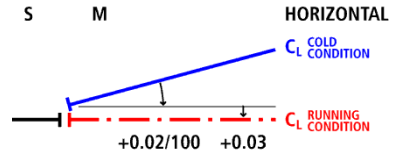
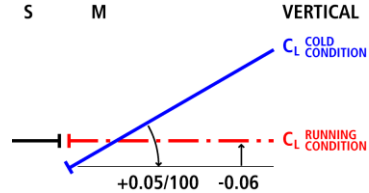



## MEASUREMENT METHODS



### Tripoint™ method

In the Tripoint method, the alignment condition can be calculated by taking three points while rotating the shaft at least 60°.

**NOTE:** The shafts should be coupled during measurement to achieve as reliable and accurate results as possible, when using the Tripoint method.

**TIP:** The larger the angle over which the three points are measured, the fewer moves, and repeat measurements will have to be made. The minimum angle between readings is 30°.



### Express Mode™ method

The Express Mode method works as the Tripoint method with the following additions.

The first position can be registered automatically, if the shafts first are rotated counterclockwise more than 3° between 6 o'clock and 12 o'clock and then clockwise more than 3°. The reading is then taken automatically when the sensors have been stationary for 2 seconds.

After recording the 1st point, the other points are taken automatically when the shafts are rotated to a new position and are kept in position for more than 2 seconds.



### Multipoint method

10 9

In the Multipoint method, the alignment condition can be calculated by recording 6 to 9 points while rotating the shafts at least  $50^\circ$ .

**NOTE:** The shafts should be coupled during measurement to achieve as reliable and accurate results as possible, when using the Multipoint method.

**TIP:** The larger the angle over which the three points are measured, the fewer moves, and repeat measurements will have to be made. The minimum angle between readings is  $10^\circ$ .



### Multipoint express method

10 9

The Multipoint express method works as the Multipoint method with the following additions.

The first position can be registered automatically, if the shafts first are rotated counterclockwise more than  $3^\circ$  between 6 o'clock and 12 o'clock and then clockwise more than  $3^\circ$ . The reading is then taken automatically when the sensors have been stationary for 2 seconds.

After recording the 1st point, the other points are taken automatically when the shafts are rotated to a new position and are kept in position for more than 2 seconds.



### Sweep mode method

9

In the Sweep mode method, the alignment condition can be calculated by recording measurement data automatically while rotating the shafts at least 90° at a moderate speed.

**NOTE:** The shafts must be coupled during measurement to achieve as reliable and accurate results as possible, when using the Sweep mode method.

**TIP:** The larger the angle over which the shafts are rotated, the fewer moves, and repeat measurements will have to be made.



### Sweep mode express method

9

The Sweep mode express method works as the Sweep mode method with the following additions.

After performing the rotation of the shafts and having been stationary for more than a second, the app continues automatically to the result, given that enough measurement data has been collected.



## **Clock method**

In the Clock method, machinery positions are calculated by taking three points with  $180^\circ$  of rotation.

The Clock method is useful when comparing the measurement results with traditional alignment methods using dial gauges and reversed rim method. The method can also be used when the machines are standing on non-horizontal foundations or when the shafts are not coupled.

## MEASUREMENT POINT REGISTRATION

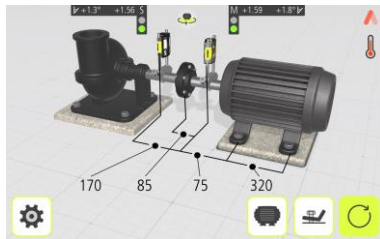

Go to measurement.



Select measurement  
method.



Tripoint™ method

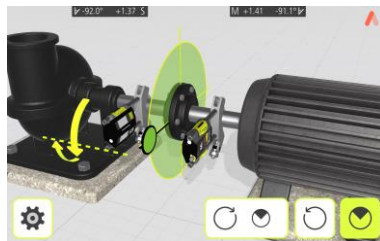

Set the sensors at approximately the same  
rotational angle at the first measurement  
position.



Touch the measurement icon,  
to register the first position.

Rotate the shafts to the next position. The shafts must be rotated over a minimum of 30°.

Red sector shows already measured zone. The Register icon is not shown if the rotation is less than 30°.

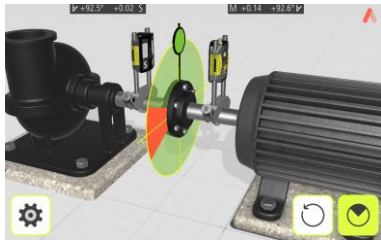

Touch the measurement icon, to register the second position.

Rotate the shafts to the third position.

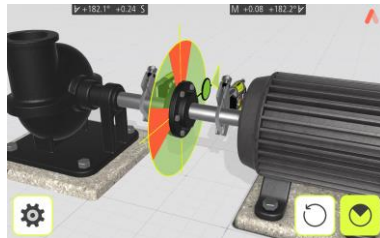

Touch the measurement icon, to register the third position.

TIP: When registering the third position at the 3 o'clock position, the sensors will already be in the right position for horizontal alignment.



## Express Mode™ method

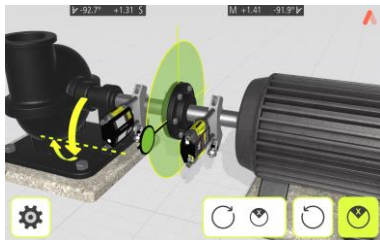

Set the sensors at approximately the same rotational angle at the first measurement position.



Touch the measurement icon.

This starts the measurement point registration and registers the first position.

The first position can be registered automatically, if the shafts first are rotated counterclockwise more than  $3^\circ$  between 6 o'clock and 12 o'clock and then clockwise more than  $3^\circ$ .

The reading is then taken automatically when the sensors have been stationary for 2 seconds.

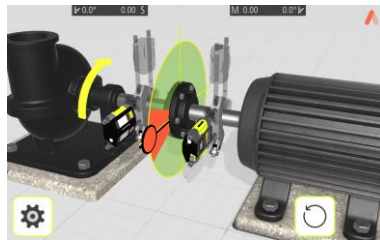

Rotate the shafts to the next position. The shafts must be rotated over a minimum of 30°.

Red sector shows already measured zone.

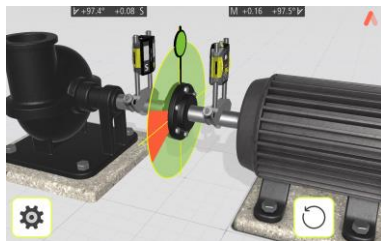

The reading is taken automatically when the sensors have been stationary for 2 seconds.

Rotate the shafts to the third position.

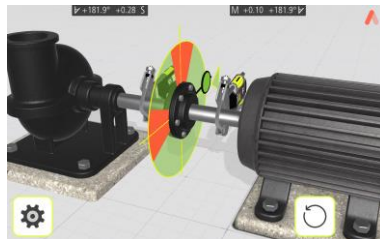

The reading is taken automatically when the sensors have been stationary for 2 seconds.

TIP: When registering the third position at the 3 o'clock position, the sensors will already be in the right position for horizontal alignment.





## Multipoint method

10 9

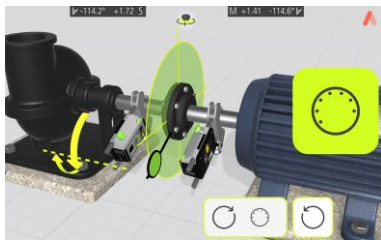

Set the sensors at approximately the same rotational angle at the first measurement position.



Touch the measurement icon, to register the first position.

Rotate the shafts to the next position. The shafts must be rotated over a minimum of  $10^\circ$ .

Red sector shows already measured zone. The Register icon is not shown if the rotation is less than  $10^\circ$ .

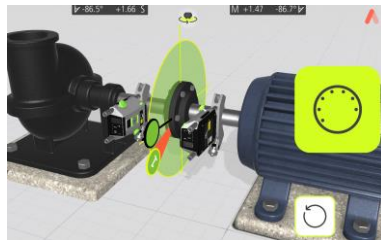

Touch the measurement icon, to register the second position.

Continue to measure. Between 6 and 9 positions can be measured.

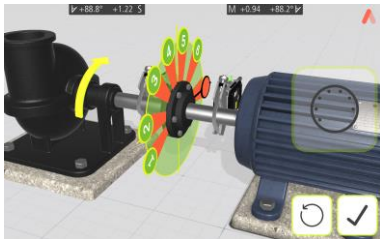

Finish measurement.



## Sweep mode method

9

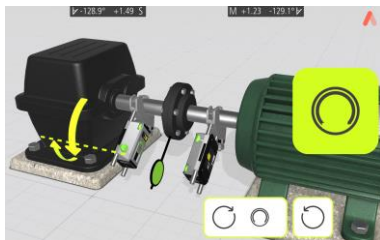

Set the sensors at approximately the same rotational angle at the position where you want to start the sweep measurement.



Touch the measurement icon, to start sweep mode.

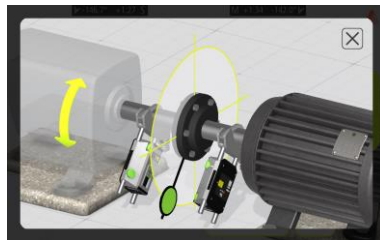

A pop-up indicating to rotate the shafts to start the measurement data collection is displayed.

Once the shafts are rotated the data collection will start and an animation will begin showing the optimum speed to rotate the shafts.

Rotate the shafts slowly in one direction (the direction the motor rotates when in use) for ideally  $180^\circ$  or more. A minimum of  $90^\circ$  is required. A slow and steady rotation will increase the amount of data and improve the result.

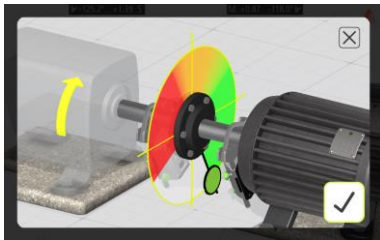

Finish measurement.

If sufficient measurement data has not been collected, an error message will show up.



The error message shows if the rotation angle was too short or if the shafts were rotated too fast, or both. (In the example above, the rotation angle was too short.)



## Clock method

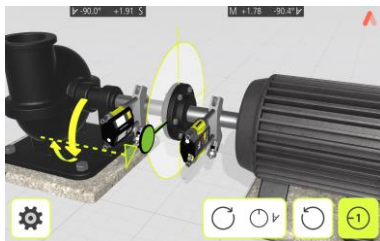

Set the sensors at approximately the same rotational angle at the first measurement position, 9 o'clock.



Touch the measurement icon, to register the first position.

Rotate the shafts to the next position, 12 o'clock.

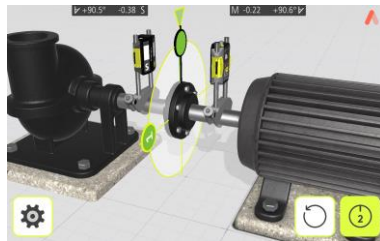

Touch the measurement icon, to register the second position.

Rotate the shafts to the third position, 3 o'clock.

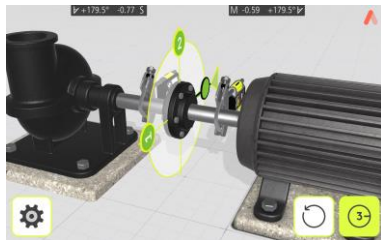

Touch the measurement icon, to register the third position.

### Clock method with disabled inclinometers

If the inclinometers are not functioning properly, e.g., in high vibrations, they can be disabled.

Go to settings to disable inclinometers.

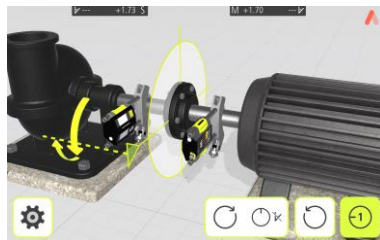

## MEASUREMENT RESULTS

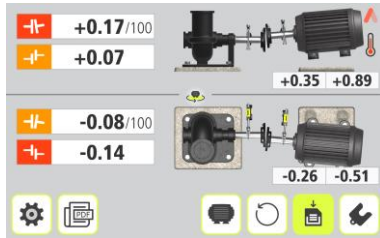

The Measurement Result screen shows coupling values and foot values in both the vertical and horizontal direction.

The symbol to the left of the coupling values indicates the angular direction and offset, and if the values are within tolerance.



Within tolerance (green).



Within double tolerance (yellow and inverted).



Out of double tolerance (red and inverted).



When a coupling is in tolerance in one direction, this is indicated with a check symbol at the motor.

## EVALUATING AND SAVING THE RESULT

The angle and offset values are used to determine the alignment quality. These values are compared with the alignment tolerances to determine whether correction is necessary. If suitable tolerances are selected in the tolerance table, the symbols described above indicate if the angle and offset values are within tolerance or not.

The foot values indicate the movable machine's foot positions where corrections can be made.

Depending on the result, the program will also guide the user.

First, the program will always guide the user to save the measurement.



Touch the save icon to save the result.

(The measurement is saved in the app and can be handled further by generating a PDF report.)

Then, if the measurement result shows that the machine is misaligned, the user will be guided to go to shimming.

If the measurement result is within tolerance and has been saved, the user will be guided to do a PDF report.

**NOTE:** It is necessary to make a PDF report for documenting and exporting the measurement from the app.



## VERTIZONTAL™

Align faster with the VertiZontal Moves feature.



First correct the vertical misalignment in the shimming screen. The system shows how much you need to remove or add shims to correct the machine vertically.



Next correct the horizontal misalignment in the alignment screen. The system goes live and will deliver real time values during the adjustment phase.

## SHIMMING



The Shimming screen shows foot values in the vertical direction as suitable shim values (0.05 mm / 1 mil).

The arrows show if shims must be added or removed to adjust the machine in the vertical direction.

The check signs show that shimming is not needed.

When shimming is completed, continue to alignment for adjustments in the horizontal direction.

6.42



Go to alignment.

## ALIGNMENT

If the machine has been adjusted vertically in the shimming screen, only the horizontal direction remains to align.

If the machine has not been adjusted in the shimming screen, alignment in the vertical direction must be done first.

### Horizontal direction

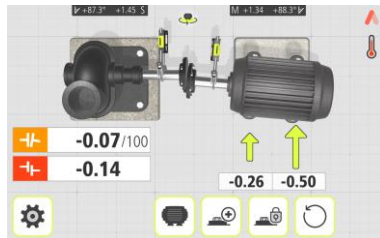

Rotate the shafts to the 3 or 9 o'clock position, if they are not already positioned there. The angle guide helps you to reach the right position.

Adjust the machine horizontally until the values for both angular and parallel alignment are within tolerance. The arrows by the feet show in which direction the machine should be moved.

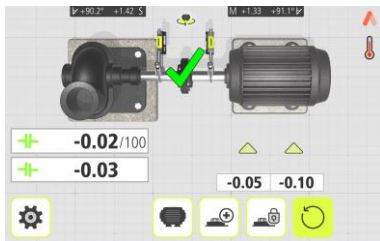

Alignment is now completed. To confirm the result, re-do the measurement.



Re-measure.

Tighten the bolts using the tightening sequence, as below.

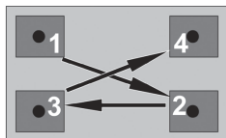

## Vertical direction

To check or align in the vertical direction, rotate the shafts to the 12 or 6 o'clock position. The angle guide helps you to reach the right position.

Adjust the machine vertically until the values for both angular and parallel alignment are within tolerance. The arrows by the feet show in which direction the machine should be moved.



## Clock method with disabled inclinometers

If the inclinometers are not functioning properly, e.g., in high vibrations, they can be disabled.

Go to settings to disable inclinometers.

When the inclinometers are disabled, use the change view icon to change from horizontal to vertical view of the machine and vice versa.



Change view.

## 2-AXIS ALIGNMENT

9

The 2-axis alignment function makes it possible to perform adjustments of the movable machine both in vertical and horizontal direction without further rotations of the shafts.

The 2-axis alignment function is usable when the shaft has limited or no possibility to control the positioning of the shafts during rotation.

Note: This function cannot be used during the following conditions:

- Uncoupled shafts.
- If the shafts rotate during correction.
- If any backlash occurs in the coupling during correction.



Touch the 2-axis alignment icon to go to the 2-axis alignment screen.

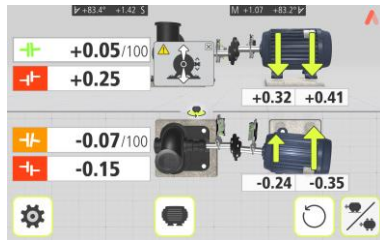

The 2-axis alignment screen shows live coupling values and foot values in both the vertical and horizontal direction.

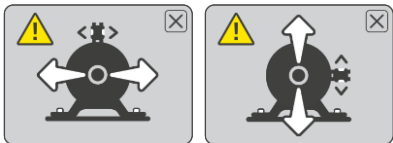

Note: If the sensors are closer to the 12 or 6 o'clock positions backlash can affect the horizontal values and if the sensors are closer to the 3 or 9 o'clock positions backlash can affect the vertical values.

## FEET LOCK FUNCTION

In some cases, the machine that is displayed as the movable machine is not movable, or maybe some of the feet are not adjustable. To perform proper alignment in these cases, the Feet Lock function can be used. This function allows you to select which feet are locked and which feet are adjustable.

Feet Lock is available both in shimming and alignment.



Touch the Feet Lock icon to enter the Feet Lock function.

Enter dimensions. The required distances are those between the first and second pairs of feet on the stationary machine and between the first pair of feet on the stationary machine and the first pair of feet on the movable machine.

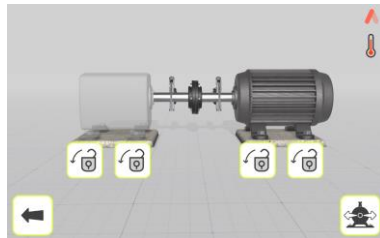

Select the two pairs of feet you want to lock.



## Feet Lock Shimming

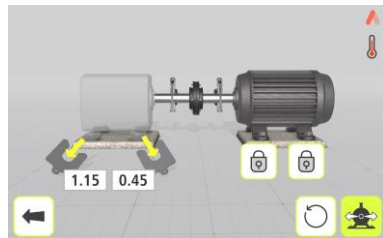

Shim values are shown for the two pairs of feet that are not locked.

## Feet Lock Alignment

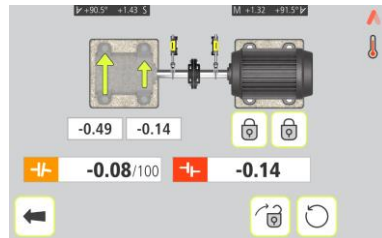

Live values are shown for the two pairs of feet that are not locked.

## MULTIPLE FEET **10** **9**

Some machines have more than two pairs of feet. To perform proper alignment in these cases, the Multiple Feet function can be used. This function allows you to select 3, 4 or 5 pairs of feet.

Multiple Feet is available both in shimming and alignment.



Touch the Multiple Feet icon to enter the Multiple Feet function.



Select numbers of pairs of feet, 3, 4 or 5.

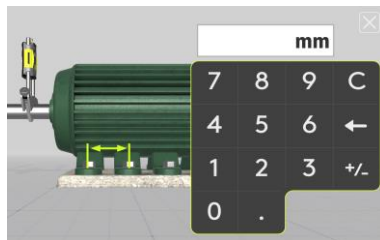

Enter distances between the pairs of feet, 1-2, 2-3...

## Multiple Feet Shimming

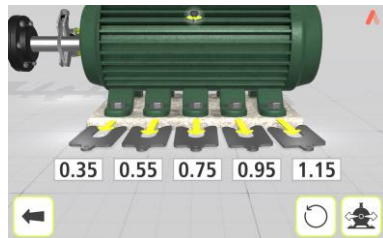

Shim values are shown for the selected pairs of feet.

## Multiple Feet Alignment



Live values are shown for the selected pairs of feet.

## SCREEN FLIP

Screen Flip enables the user to see the machine set-up from the actual view.



Touch the Screen Flip icon to change view.

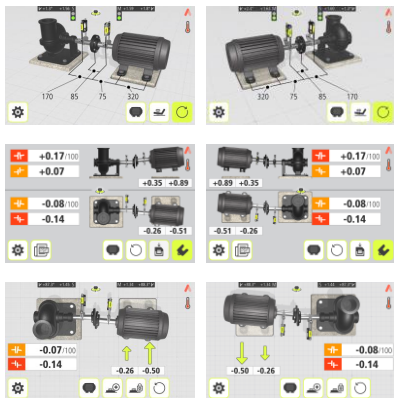

## COUPLING GAP

### Configuration



Go to the configuration screen.



Select coupling type.

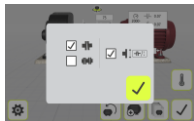

Activate coupling gap.

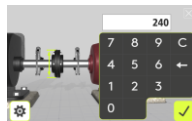

Enter coupling diameter.

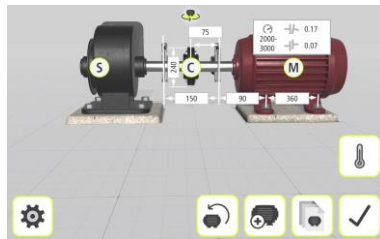

## Measurement results

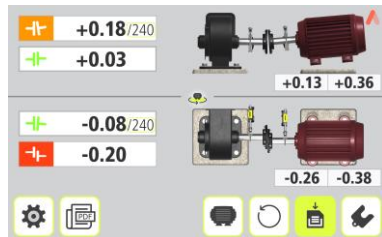

The angular error is shown per coupling diameter.

When coupling gap is activated, the coupling diameter is editable in the result screen.

## SPACER SHAFT

10 9

The spacer shaft function is used when the alignment is performed on machinery using a membrane coupling. The membrane coupling is a typical high-performance coupling, with no backlash, used for maintenance free operation. It is also suitable for high speeds or high temperature applications.

Membrane couplings are normally designed with a spacer shaft between two flexible elements making it possible to compensate for both axial, radial (offset) and angular misalignment. Each flexible element normally consists of a steel disc pack (diaphragms) which has a high torsional stiffness. A single flexible element can only compensate for angular misalignment and cannot take any radial misalignment. To compensate for all types of misalignment, the membrane couplings use two flexible elements with a spacer in between.

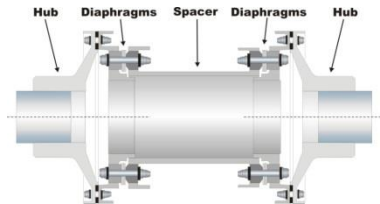

When using the spacer shaft function, the misalignment is presented as an angle for each flexible element. The angles can be compared directly to the figures on allowed misalignment normally delivered from the coupling manufacturer.

Depending upon the alignment condition, there can be differences in angle between the two flexible elements. The pictures below show different examples of how the angles in the flexible elements can be.





## Configuration



Go to the configuration screen.



Select coupling type.



Activate spacer shaft.

Measure and enter distances.



You must enter all the distances. The distance between the sensors, the “spacer shaft length”, the distance between the “end of the spacer shaft” and the M-sensor, the distance between the M-sensor and the first pair of feet and the distance between the first and the second pair of feet.

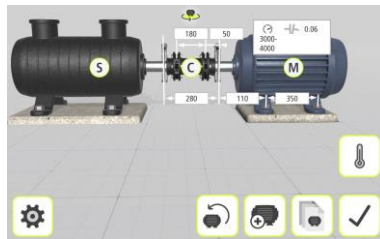

## Measurement point registration

See selected measurement method, the Tripoint method, the Express Mode method or the Clock method.

Generally, the measurement procedure for spacer shaft works in the same way as for standard coupling, except for the two angular values.

## Measurement results

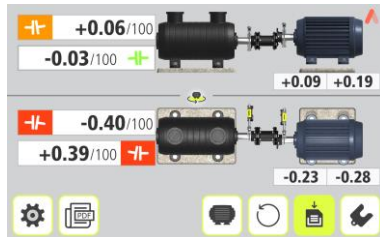

The Measurement Result screen shows coupling values and foot values in both the vertical and horizontal direction.

The symbol to the left or right of the coupling values indicates the angular direction, and if the values are within tolerance.

## Evaluating and saving the result

The angle values are used to determine the alignment quality. These values are compared with the alignment tolerance to determine whether correction is necessary. If suitable tolerance is selected in the tolerance table, the symbols described above indicate if the angle values are within tolerance or not.

The foot values indicate the movable machine's foot positions where corrections can be made.



Touch the save icon to save the result.

(The measurement is saved in the app and can be handled further by generating a PDF report.)

## Shimming

See shimming for standard coupling.

## Alignment

If the machine has been adjusted vertically in the shimming screen, only the horizontal direction remains to align.

If the machine has not been adjusted in the shimming screen, alignment in the vertical direction must be done first.

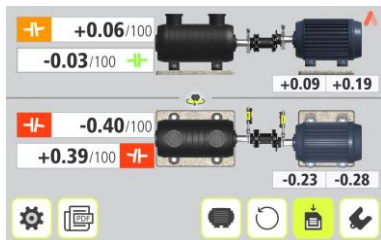

Adjust the machine horizontally until both the angular values are within tolerance. The arrows by the feet show in which direction the machine should be moved.

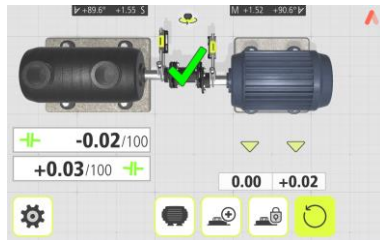

Alignment is now completed. To confirm the result, re-do the measurement.



Re-measure.

## MOTOR & STATIONARY MACHINE

10 9

Motor color and stationary machine type can be selected in the configuration screen.

### Motor

M

Select motor color.

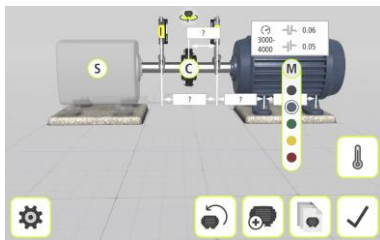

Select grey, blue, green, yellow, or red.

### Stationary machine

S

Select stationary machine type.



Select undefined machine, centrifugal compressor, alternator, lobe compressor, blower, fan, gear box or pump.

## SENSOR DISPLAY 9

When using the M9 and S9 sensors a Sensor Display is available in the start screen.



Open Sensor Display.



Raw sensor values (Y, X and rotational angle) are shown, together with an illustration of each sensor where a red dot is showing the laser hit at the detector.

## PDF REPORT

A PDF report with several measurements can be generated.



Touch the PDF icon to create a PDF report.

(The PDF icon is found in the result screen and in the setting screen.)

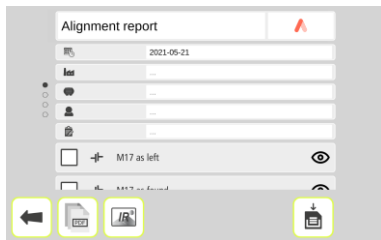

## Enter data

Touch the white field at the top to enter a header for the PDF report.

Touch the white fields to enter date, site, machine, user and note.

## Select files



Touch the check box to the left to select files.

## Generate and save the PDF report



Touch the save icon to generate and save the PDF report.

Enter a file name and confirm.

The PDF report will then be shown, for further handling. It can be downloaded or shared using standard features of the tablet.

## View a file



Touch the eye to view a file.

## PDF-report list



Touch the PDF list icon to view existing PDF-reports.

## IR Pictures



Touch the IR Picture icon to import IR pictures.

## Customized logo

Touch the logo up to the right to change it.

Add your logo as a PNG or JPG file. The maximum recommended file size is 500 kB.

The maximum space for logo on the PDF report is 51 x 17 mm.



## OTHER FEATURES

### Looseness indicator



The system has a function for detecting coupling backlash and looseness to achieve optimum accuracy. The system will display the looseness indicator if one of the following conditions is met:

- The M and S units are more than  $3^\circ$  apart.

- The mutual angular position changes more than  $0.7^\circ$  from that when the first measurement point was taken.

When the coupling backlash or looseness is eliminated to avoid any of the above conditions, the looseness indicator will automatically disappear.

### Target Value symbol



When Target Values are used in the measurement, this is indicated with the Target Value symbol in the upper right corner of the screen.

## SETTINGS

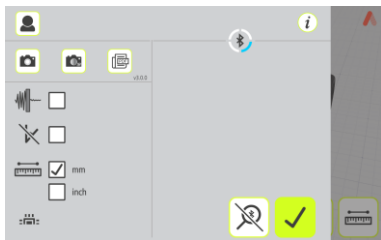

### User Log in



Touch the User icon to log in to the ACOEM Augmented Mechanics Platform.

### Info



Touch the Info icon to go to website for downloading user manual.

### Photo



Touch the Photo icon to take a photo.

### Flir One 10 9



Touch the IR Photo icon to go to the Flir One app.

### PDF report



Touch the PDF icon to create a PDF report.

### Privacy policy



Touch the Privacy Policy icon to go to website for information about privacy policy.

### Intelligent screen filter and sampling time



Activate or deactivate intelligent screen filter with increased sampling time.

Note: The intelligent screen filter should be deactivated for normal operation, and only activated in environments with severe vibrations.

### Inclinometer Off



Deactivate inclinometer.

### 2-axis alignment Off



Deactivate 2-axis alignment.

### Measurement unit



Select mm or inch.

### Best resolution

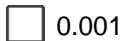

Select 0.001 mm or 0.01 mils.

## Bluetooth settings

When entering settings, the system starts searching for pair able sensors.

Only ACOEM sensors that are switched on, will be discovered.

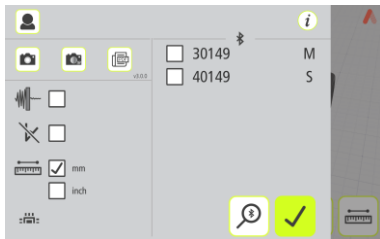

Pair able sensors will appear in the list.



Select the sensors to pair.

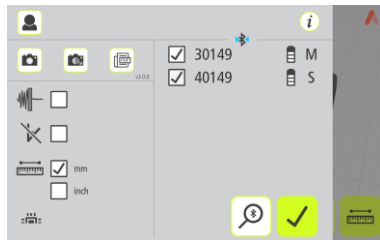

Paired units are marked with a check mark.

If there are units paired to the app, they must be unpaired before it is possible to pair new units.



To unpair units, touch the check mark icon beside the units.

## Search



Starts searching for pairable sensors.

## Cancel search



Stops searching for pairable sensors.

## Confirm



Exits the Settings and returns to the application.

## CLOUD SYNCHRONIZATION

Accessing the ACOEM Augmented Mechanics Platform allows for easy collaborative work, sharing machines, results, and providing a centralized multi-technical view (alignment, vibration) for a more effective decision making on maintenance action and plant performance.

### User authentication

To exchange data between the ACOEM Horizontal Shaft Alignment app and the cloud, the user must be logged in with a valid login and password. To do so, it is possible to authenticate from the app settings.

Click on the User icon and fill in your login and password that were provided at the creation of your account on the ACOEM Augmented Mechanics Platform (ai.acoem.com).



### NOTE!

The validity of your information will be checked every time a synchronize action is triggered from the app.

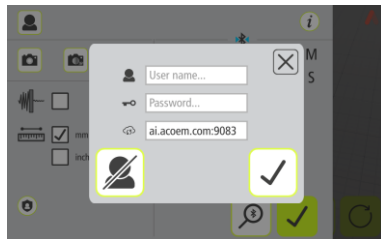

Confirm.



Log out.

## Upload a machine

Machines that are created in the configuration screen can be uploaded to the cloud.

To do so, from the machine list, display the machine details and touch the upload icon.



Upload to cloud.

## Upload all completed work orders

From the machine list, touching the cloud synchronization icon will upload all completed and closed work orders.



Cloud synchronization.

## Download available work orders

From the machine list, touching the cloud synchronization icon will automatically download all work orders assigned to the user logged in to the app.

Machines to be measured with due date will then appear in the machine list.



Cloud synchronization.

## Completing a work order

Once a job is performed, the work order must be closed by the user prior to the upload to the cloud.

Once the work order is closed, its status is automatically updated in the machine list.

It means that the machine results and report are ready to be uploaded to the cloud and shared with other users.

A work order can either be closed from the result screen or from the machine list, by touching the work order closing icon.



Close the work order.





## **SHAFT ALIGNMENT VERTICAL MACHINES**

### **INTRODUCTION**

Shaft alignment: Determine and adjust the relative position of two machines that are connected, such as a motor and a pump, so that the rotational centers of the shafts are collinear, when the machines are working at a normal operating temperature. Correction of vertical shaft alignment is done by moving the flange of the machine until the shafts are aligned within given tolerances. A tolerance table is available in the system.



The system has two measuring units that are placed on each shaft by using the fixtures supplied with the system.



After rotating the shafts to different measuring positions, the system calculates the relative distance between the two shafts in two planes. The distances between the two measuring planes, distance to the coupling, number of bolts and pitch circle diameter are entered into the system. The display box then shows the actual alignment condition together with the position of the feet. Adjustment of the machine can be made according to the values displayed. The angular misalignment is corrected by placing shims under the bolts and offset is corrected by moving them laterally.

The alignment results can be saved for further documentation purposes.

## PRE-ALIGNMENT FUNCTIONS

To obtain the best possible conditions for shaft alignment, it is necessary to perform some pre-alignment checks. In many cases it is necessary to make these checks to obtain precise alignment. It is often impossible to reach the desired alignment results if you do not make any pre-alignment checks.

Before going on site, check the following:

What are the required tolerances?

Any offsets for dynamic movements?

Are there any restrictions for mounting the measuring system?

Is it possible to rotate the shafts?

What shim size is needed?

Before setting up the alignment system on the machine, check the machine foundation, bolt, and shim conditions. Also check if there are any restrictions in adjusting the machine (if e.g., there is enough space to move the machine).

After the visual checks have been performed, there are some conditions that must be considered:

- Check that the machine has the right temperature for alignment.
- Take away old rusty shims (check that you can remove shims).
- Check coupling assembly and loosen the coupling bolts.
- Check soft foot conditions.
- Mechanical looseness.
- Check coupling and shaft run-out.

- Pipe work strain.
- Coarse alignment.
- Check coupling gap (axial alignment).

The Pre-Alignment app can be used for several Pre-Alignment checks.

## STARTING

Turn on the sensors.

Turn on the tablet.



Start the Vertical Shaft Alignment app.

The Vertical Shaft Alignment app works with the sensors M7 & S7, M10 & S10 and M9 & S9.

Go to settings for connecting the sensors if they are not already connected.



Settings.

Settings are described at the end of the chapter.

## SENSOR DEPENDENT FUNCTIONS

Some functions work only with the sensors M10 & S10 and/or M9 & S9. These functions are marked with a sensor 10 and/or sensor 9 symbol.



Require M10 & S10.



Require M9 & S9.

\*) M7 & S7 with Smart key work as M10 & S10.

## MOUNTING

The sensors are mounted as described in chapter “Shaft Alignment Horizontal Machines”.

## MACHINE CONFIGURATION

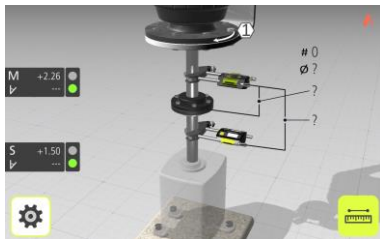

The screen displays the movable machine. The traffic lights show green when the laser hits the detector.



Touch the distance icon.

## Measure and enter distances

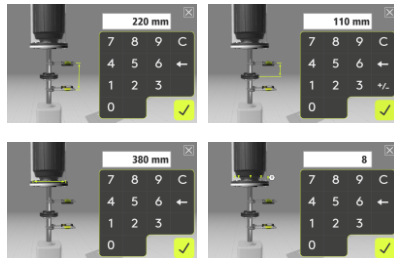

You must enter all the distances. The distance between the sensors, the distance between the center of the coupling and the M-sensor, the pitch circle diameter, and the number of bolts.

## Enter tolerances

Alignment tolerances depend to a large extent on the rotation speed of the shafts. Machine alignment should be carried out within the manufacturer's tolerances.

The provided table can be helpful if no tolerances are specified. It is also possible to enter customized tolerances.

The tolerances are the maximum allowed deviation from desired values.

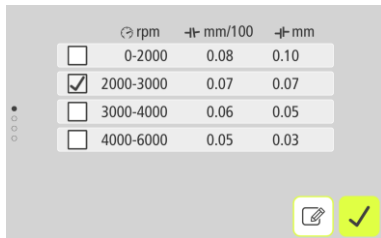

	rpm	mm/100	mm
<input type="checkbox"/>	0-2000	0.08	0.10
<input checked="" type="checkbox"/>	2000-3000	0.07	0.07
<input type="checkbox"/>	3000-4000	0.06	0.05
<input type="checkbox"/>	4000-6000	0.05	0.03

Tolerance Table mm-mode

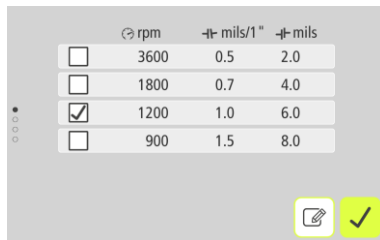

	rpm	mils/1"	mils
<input type="checkbox"/>	3600	0.5	2.0
<input type="checkbox"/>	1800	0.7	4.0
<input checked="" type="checkbox"/>	1200	1.0	6.0
<input type="checkbox"/>	900	1.5	8.0

Tolerance Table inch-mode



Select the tolerance to use in the alignment by touching its check box to the left.



Confirm.



Touch the edit icon to enter and edit customized tolerances.

	rpm	$\pm$ mm/100	$\pm$ mm
<input type="checkbox"/>	0-2000	0.08	0.10
<input checked="" type="checkbox"/>	2000-3000	0.07	0.07
<input type="checkbox"/>	3000-4000	0.06	0.05
<input type="checkbox"/>	4000-6000	0.05	0.03
<input type="checkbox"/>	?	?	?

Editing mode for customized tolerances



## MEASUREMENT METHODS



### Clock method

In the Clock method, machinery positions are calculated by taking three points with  $180^\circ$  of rotation.

The Clock method is useful when comparing the measurement results with traditional alignment methods using dial gauges and reversed rim method. The method can also be used when the machines are standing on non-horizontal foundations or when the shafts are not coupled.



### Tripoint™ method

10 9

In the Tripoint method, the alignment condition can be calculated by taking three points while rotating the shaft at least  $60^\circ$ .

**NOTE:** The shafts should be coupled during measurement to achieve as reliable and accurate results as possible, when using the Tripoint method.

**TIP:** The larger the angle over which the three points are measured, the fewer moves, and repeat measurements will have to be made. The minimum angle between readings is  $30^\circ$ .



## Express Mode™ method



In the Express Mode method, the alignment condition can be calculated by recording three points while rotating the shafts at least 60°.

After recording the 1st point, the other points are taken automatically when the shafts are rotated to a new position and are kept in position for more than 2 seconds.

**NOTE:** The shafts should be coupled during measurement to achieve as reliable and accurate results as possible, when using the Express Mode method.

**TIP:** The larger the angle over which the three points are measured, the fewer moves, and repeat measurements will have to be made. The minimum angle between readings is 30°.

## MEASUREMENT POINT REGISTRATION

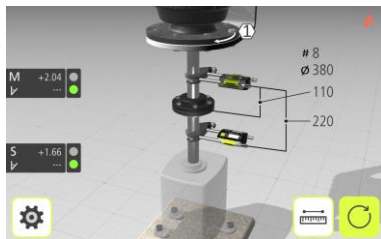

Go to measurement.



Select measurement  
method.



**Clock method**

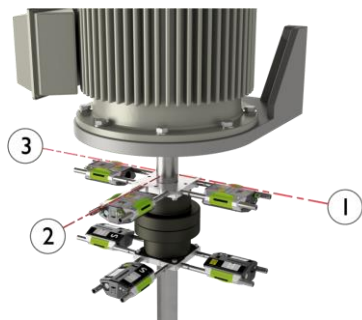

Place yourself at the position corresponding to the second measurement position, where it is easiest to turn the shafts through 180°.

The first measurement position must be at bolt number 1.

Tip: Mark the positions 1, 2 and 3 before you start measuring.

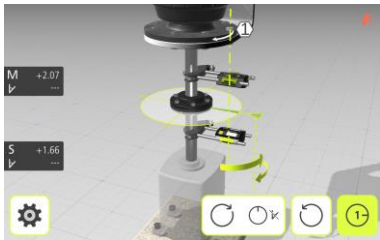

Set the sensors at approximately the same rotational angle at the first measurement position, with bolt number 1 to the right.



Touch the register icon to register the first position.

Rotate the shafts  $90^\circ$  to the second position (where you are standing).

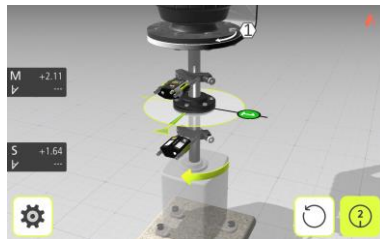

Touch the register icon to register the second position.

Rotate the shafts 90° to the third position, to the left.

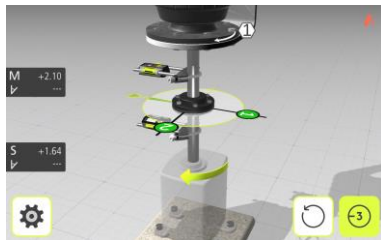

Touch the register icon to register the third position.



**Tripoint™ method**

**10 9**

Before starting the measurement, you must select a bolt to be bolt number 1.

The first measurement position must be at bolt number 1.

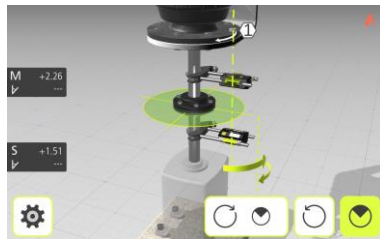

Set the sensors at the first measurement position.



Touch the measurement icon, to register the first position.

Rotate the shafts to the next position. The shafts must be rotated over a minimum of 30°.

Red sector shows already measured zone. The Register icon is not shown if the rotation is less than 30°.

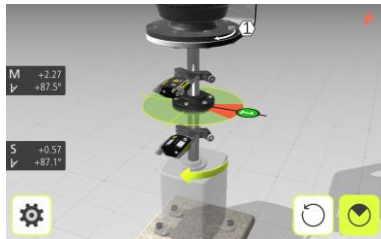

Touch the measurement icon, to register the second position.

Rotate the shafts to the third position.

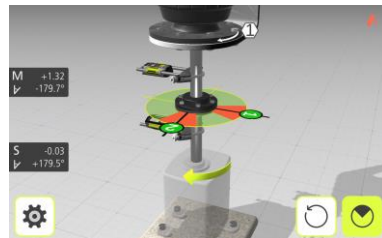

Touch the measurement icon, to register the third position.



## Express Mode™ method

10 9

Before starting the measurement, you must select a bolt to be bolt number 1.

The first measurement position must be at bolt number 1.

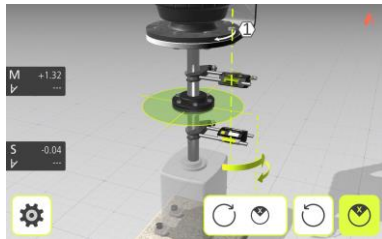

Set the sensors at the first measurement position.



Touch the register icon to start the measurement point registration and register the first position.

The first position can be registered automatically, if the shafts first are rotated counterclockwise more than  $3^\circ$  and then clockwise more than  $3^\circ$ .

The reading is then taken automatically when the sensors have been stationary for 2 seconds.

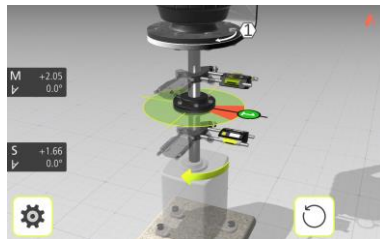

Rotate the shafts to the next position. The shafts must be rotated over a minimum of 30°.

Red sector shows already measured zone.

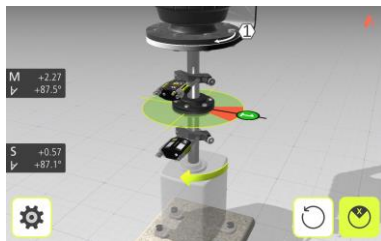

The reading is taken automatically when the sensors have been stationary for 2 seconds.

Rotate the shafts to the third position.

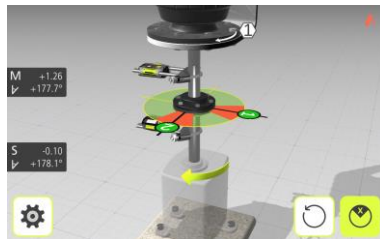

The reading is taken automatically when the sensors have been stationary for 2 seconds.



## MEASUREMENT RESULTS

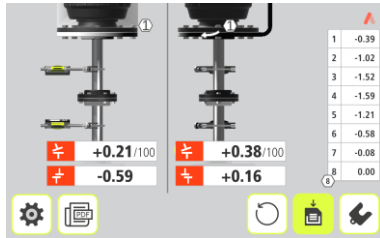

The Measurement Result screen shows coupling values in both directions, and bolt values.

The symbol to the left of the coupling values indicates the angular direction and offset, and if the values are within tolerance.



Within tolerance (green).



Within double tolerance (yellow and inverted).



Out of double tolerance (red and inverted).



When a coupling is in tolerance in one direction, this is indicated with a check symbol at the motor.

## EVALUATING AND SAVING THE RESULT

The angle and offset values are used to determine the alignment quality. These values are compared with the alignment tolerances to determine whether correction is necessary. If suitable tolerances are selected in the tolerance table, the symbols described above indicate if the angle and offset values are within tolerance or not.

The bolt values indicate the movable machine's bolt positions where corrections can be made.

Depending on the result, the program will also guide the user.

First, the program will always guide the user to save the measurement.



Touch the save icon to save the result.

(The measurement is saved in the app and can be handled further by generating a PDF report.)

Then, if the measurement result shows that the machine is misaligned, the user will be guided to go to shimming.



Go to shimming

If the measurement result is within tolerance and has been saved, the user will be guided to do a PDF report.

**NOTE:** It is necessary to make a PDF report for documenting and exporting the measurement from the app.

## SHIMMING



The Shimming screen shows bolt values as suitable shim values (0.05 mm / 1 mil).

Adjust the angular error by placing shims under the bolts as required.

The arrow shows if shims must be added to adjust the machine.

The check sign shows that shimming is not needed.

When shimming is completed, continue to alignment for adjustments of parallel offset.



Go to alignment.

## ALIGNMENT



If the angular error has been correctly adjusted in the shimming screen the angular value should now be in tolerance.

Now adjust the parallel offset in both directions. The parallel offset is displayed live in the first direction when the sensors are placed in position number 1, and in the second direction when they are placed in position number 2.

Check that both the angular value and the parallel offset are within the required tolerances once the adjustments are completed.

Alignment is now complete. To confirm the result, re-do the measurement.



Re-measure.

## PDF REPORT

A PDF report with several measurements can be generated.



Touch the PDF icon to create a PDF report.

(The PDF icon is found in the result screen and in the setting screen.)

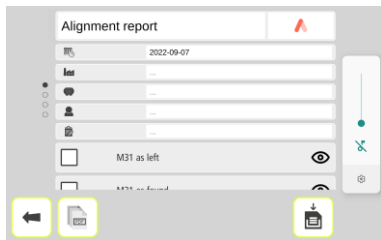

## Enter data

Touch the white field at the top to enter a header for the PDF report.

Touch the white fields to enter date, site, machine, user and note.

## Select files



Touch the check box to the left to select files.

## Customized Logo

Touch the logo up to the right to change it.

## Generate and save the PDF report



Touch the save icon to generate and save the PDF report.

Enter a file name and confirm.

The PDF report will then be shown, for further handling. It can be downloaded or shared using standard features of the tablet.

## View a file



Touch the eye to view a file.

## PDF-report list



Touch the PDF list icon to view existing PDF-reports.

## SETTINGS

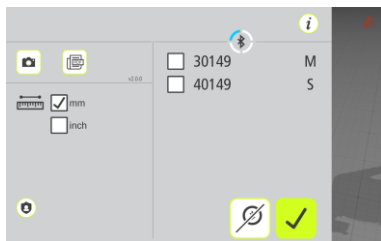

### Info



Touch the Info icon to go to the website for downloading user manual.

### Photo



Touch the Photo icon to take a photo.

### PDF report



Touch the PDF icon to create a PDF report.

### Measurement unit



Select mm or inch.

### Best resolution

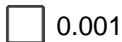

Select 0.001 mm or 0.01 mils.

### Privacy policy



Touch the Privacy Policy icon to go to website for information about privacy policy.

## **Bluetooth settings**

See Shaft Alignment Horizontal Machines.





## PRE-ALIGNMENT



## STARTING

Turn on the sensors.

Turn on the tablet.



Start the Pre-Alignment app.

The Pre-Alignment app works with the Run-Out probe P1, and the sensors M7 & S7, M10 & S10 and M9 & S9.

Go to settings for connecting the sensors if they are not already connected.



Settings.

Settings are described at the end of the chapter.

## HOME MENU

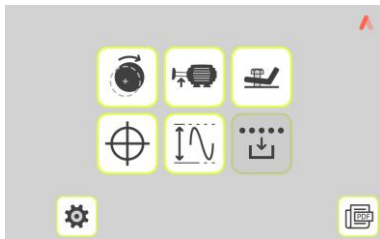

Run-Out



Bearing Clearance



Softcheck ROP



Sensor Display



Max Min ROP



Sensor Log



Settings



PDF report

Run-Out, Bearing Clearance, Softcheck ROP, Sensor Display and Max Min ROP work with the Run-Out probe P1.

Sensor Display and Sensor Log work with the sensors M7 & S7, M10 & S10 and M9 & S9.

## RUN-OUT



Start Run-Out.

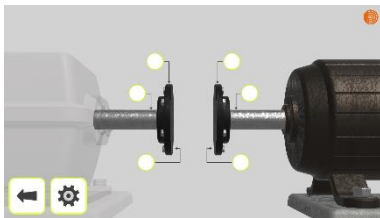

Select a position to measure.

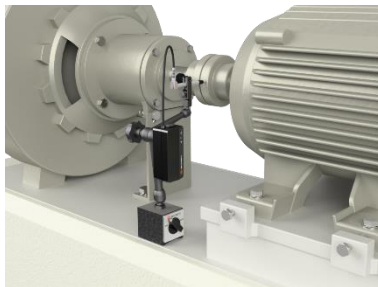

Place the Run-Out Probe on the measurement object.

## Rim

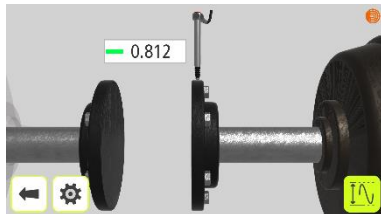

Make sure that the Run-Out Probe is at a suitable part of the measuring range before starting the measurement.



Start measuring run-out.

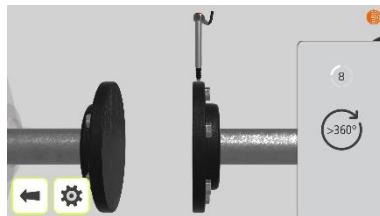

Rotate the shaft  $>360^\circ$ .

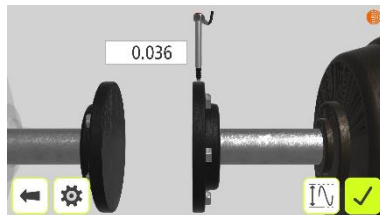

Confirm the measurement.



## Shaft

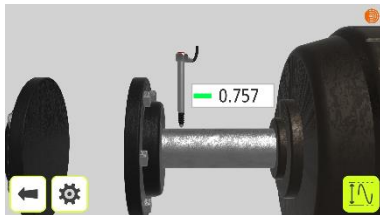

Start measuring run-out.

Rotate the shaft  $>360^\circ$ .



Confirm the measurement.

## Face

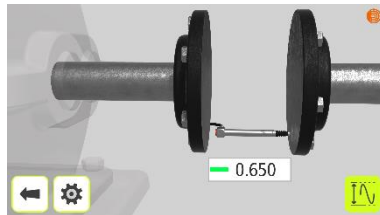

Start measuring run-out.

Rotate the shaft  $>360^\circ$ .



Confirm the measurement.

## Result

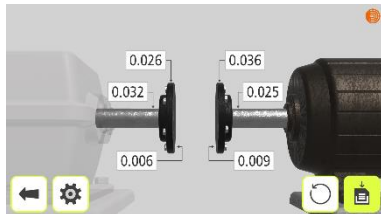

Touch the save icon to save the result.

(The measurement is saved in the app and can be handled further by generating a PDF report.)

## BEARING CLEARANCE



Start Bearing Clearance.

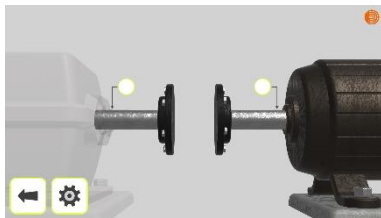

Select a position to measure.



Place the Run-Out Probe on the measurement object.

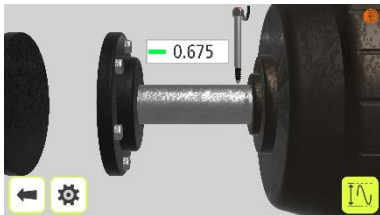

Make sure that the Run-Out Probe is at a suitable part of the measuring range before starting the measurement.



Start measuring bearing clearance.

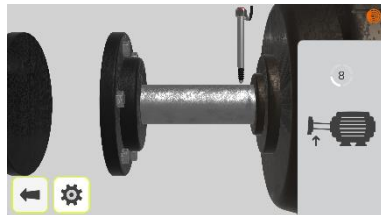

Lift the shaft.

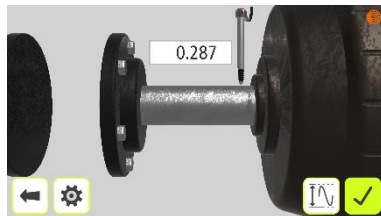

Confirm the measurement.



## Result

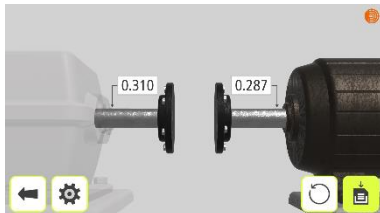

Touch the save icon to save the result.

(The measurement is saved in the app and can be handled further by generating a PDF report.)

## SOFTCHECK ROP



Start Softcheck ROP.



A soft foot condition needs to be corrected before any alignment takes place. If not, the measurement result will be of no value. It is more or less impossible to establish if there is a soft foot condition without using some kind of measurement tool. The Softcheck ROP application checks each foot and displays the result in mm or mils.

Check that all foot bolts are firmly tightened.

## Measurement value registration

The program will guide you to the feet.

The first foot.



1. Place the Run-Out Probe at the first foot.
2. Start measuring.



Touch the measurement icon.



3. Loosen the bolt fully and wait a few seconds.
4. Tighten the bolt firmly, preferably with a dynamometric wrench.
5. Register the measurement value.



Touch the confirmation icon.

Repeat the procedure at the rest of the feet.

The second foot.



The fourth foot.



The third foot.

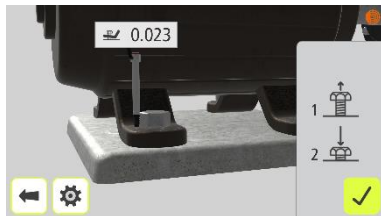

## Measurement result

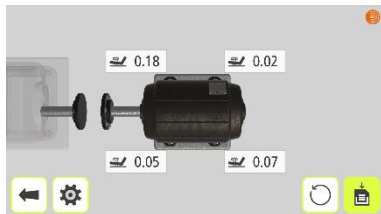

Touch the save icon to save the result.

(The measurement is saved in the app and can be handled further by generating a PDF report.)

## Corrections

Make the necessary corrections and then check each foot again (the values show approximately how many shims that are needed to eliminate the soft foot).

Re-measurements can be done by touching the re-measure icon to re-measure all feet, or by touching a single foot to re-measure just that foot.



Re-measure all feet.



Re-measure a single foot.

## SENSOR DISPLAY ROP



Start Sensor Display.

The Sensor Display for the Run-Out Probe can be used for different applications where you want to use the readings from the linear sensor in various ways. The program is used with up to two sensors, P, connected to the display unit.

The Sensor Display application shows the values from both sensors. Each sensor is measuring the distance (d). The displayed values are shown live. They can also be zeroed to increase the usage in several applications. It is also possible to register measuring values.

When the Run-Out Probe is used to measure the position of an object to a rotational center, the values can be zeroed and then halved.

Make sure that the Run-Out Probe is at a suitable part of the measuring range before zeroing.

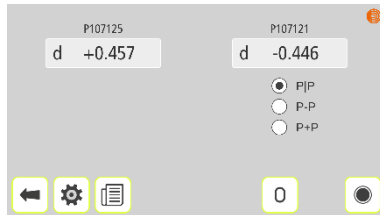

When entering Sensor Display ROP, raw data from the connected Run-Out Probes are displayed.

## Zero values



Zero values.

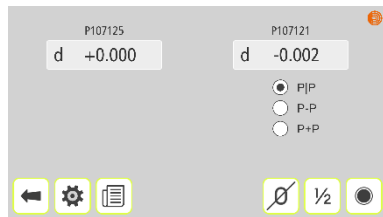

After zeroing values, they can also be halved.  
It is also possible to return to raw values.



Halve values.



Return to raw values.

## Register values



Register values.

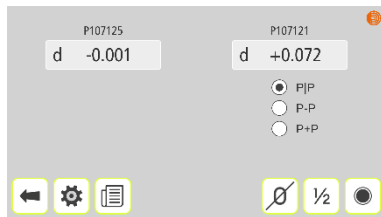

Registered values will be added to the list.



Go to list.

## P|P, P-P and P+P

The values from the second pen (to the right) can either be displayed separately or relative to the first pen (to the left), either P-P or P+P.

## List

	🕒	Type	d P107125	d P107121	P P	🔴
1	13:12	REL	-0.001	+0.074	+0.074	
2	13:12	REL	-0.001	+0.073	+0.073	
3	13:12	REL	-0.001	+0.073	+0.073	
4	13:12	REL	-0.001	+0.037	+0.037	
5	13:14	REL	+0.001	+0.139	+0.139	
6	13:14	REL	+0.000	+0.070	+0.070	
7	13:15	REL	+0.000	-0.014	-0.014	

🏠 ⚙️ 🎯 📄



Save the list.



Return to Sensor Display.



## MAX MIN ROP



Start Max Min ROP.

Max Min ROP for the Run-Out Probe can be used for several applications where the user wants to measure the displacement of an object to a rotational center.

Measuring values from the Run-Out Probe are continuously registered under a dedicated sampling time.

Results from the measurement are shown directly on the screen. The maximum value (Max) and the minimum value (Min) are shown together with the difference (Max-Min).

The measuring result can be added to a list, that can be saved for further documentation.

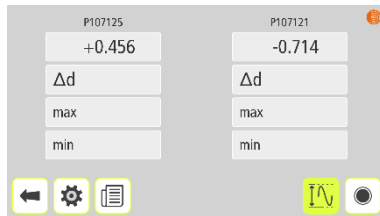

When entering Max Min ROP, raw data from the connected Run-Out Probes are displayed.

Adjust the position of the probes to be within the measuring range, using the raw data on the screen.



Measure max min.

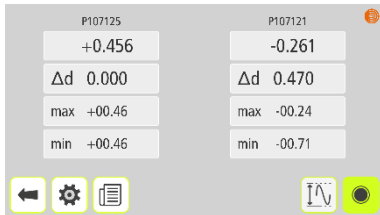

When max min is measured the difference during the measurement is displayed. The max and min values are also displayed.

The displayed measurement result can be registered and added to the list.



Register the measurement.

When the measurement is registered it will be added to the list.



Go to the list.

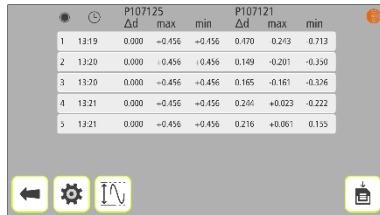

Touch the save icon to save the list.

(The measurement is saved in the app and can be handled further by generating a PDF report.)

## SENSOR DISPLAY TD



Start Sensor Display.

On the Sensor Display for TD-units, the values from the connected sensors are displayed. Values can be zeroed, halved, registered, and stored in a list that can be saved.



When entering Sensor Display TD, raw data from the connected sensors are displayed.

## Zero values



Zero values.



After zeroing values, they can also be halved.



Halve values.

## Register values



Register values.



Registered values will be added to the list.



Go to list.

If needed, it is possible to return to raw values.



Return to raw values.

## List

	Type	Y:	X:	59-80126	Y:	X:	M9-70125
1	1:21 PM	REL +0.00	-0.10	+0.00	+0.00	-0.01	-0.10
2	1:21 PM	REL -0.10	-0.14	+0.00	+0.15	+0.03	+0.00
3	1:21 PM	REL -0.14	-0.03	+0.00	+0.20	-0.22	+0.00
4	1:22 PM	REL -0.29	-0.13	+0.00	+0.40	-0.32	+0.00
5	1:22 PM	REL -0.45	-0.38	+0.20	+0.65	+0.49	+0.20
6	1:23 PM	REL -0.45	+0.81	+0.20	+0.67	-0.27	+0.20
7	1:23 PM	REL -0.46	+0.68	+0.10	+0.67	-0.34	+0.20

Navigation icons: back, settings, target, save.



Save the list.



Return to Sensor Display.

## SENSOR LOG TD



Start Sensor Log TD.

On the Sensor Log for TD-units, the values from the connected sensors can be recorded to file.

## Record values



When entering Sensor Log TD, raw data from the connected sensors are displayed.



Create a file for storing values.



Zero values, if needed.

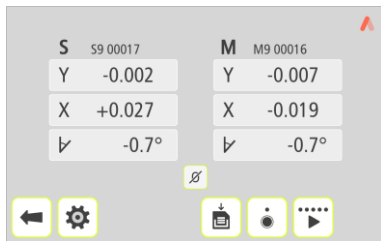

Record single values.



Start continuous recording.

When continuous recording is started values will be recorded according to the selected interval time in settings.

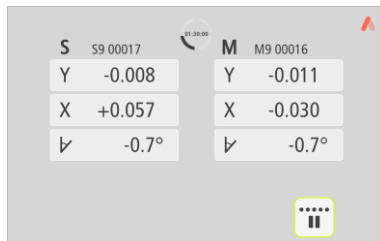

Pause continuous recording.

Recording can be paused and started several times and all the recorded values will be stored in the same file.

Recorded values will be added to the list and can be seen there until finish recording.



Go to list.



Finish recording to a file.

The recorded values are stored in a text file with a time stamp for each recording.

## List

	S9 00017			M9 00016			
🕒	Y	X	↕	Y	X	↕	🔴
01:30:00	-0.007	+0.057	-0.7	-0.010	-0.038	-0.7	
01:29:45	-0.008	+0.056	-0.7	-0.009	-0.038	-0.7	
01:29:30	-0.007	+0.057	-0.7	-0.010	-0.037	-0.7	
01:29:15	-0.007	+0.057	-0.7	-0.011	-0.038	-0.7	
01:29:00	-0.007	+0.057	-0.7	-0.011	-0.032	-0.7	
01:28:45	-0.008	+0.057	-0.7	-0.010	-0.038	-0.7	
01:28:30	-0.008	+0.057	-0.7	-0.010	-0.038	-0.7	

⚙️ 📄



Return to Sensor Log.



## PDF REPORT

A PDF report with several measurements can be generated.



Touch the PDF icon to create a PDF report.

(The PDF icon is found in the home menu and in the setting screen.)

### Enter data

Touch the white field at the top to enter a header for the PDF report.

Touch the white fields to enter date, site, machine, user and note.

### Select files



Touch the check box to the left to select files.

## Customized logo

Touch the logo up to the right to change it.

### Generate and save the PDF report



Touch the save icon to generate and save the PDF report.

Enter a file name and confirm.

The PDF report will then be shown, for further handling.

### View a file



Touch the eye to view a file.

### PDF-report list



Touch the PDF list icon to view existing PDF-reports.

## SETTINGS

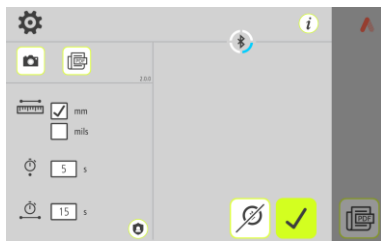

### Info



Touch the Info icon to go to website for downloading user manual.

### Photo



Touch the Photo icon to take a photo.

### PDF report



Touch the PDF icon to create a PDF report.

### Measurement unit



Select mm or inch.

### Sampling time



Touch the white box to enter sampling time.

### Interval time



Touch the white box to enter interval time.

## Privacy policy



Touch the Privacy Policy icon to go to website for information about privacy policy.

## Bluetooth settings

When entering settings, the system starts searching for pair able sensors.

Only ACOEM sensors that are switched on, will be discovered.

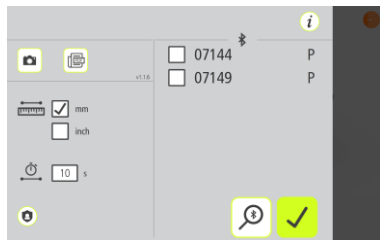

Pair able sensors will appear in the list.



Select the sensors to pair.  
(Maximum two units.)

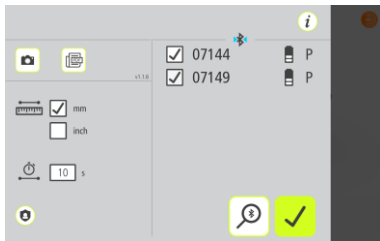

Paired units are marked with a check mark.

If there are units paired to the app, they must be unpaired before it is possible to pair new units.



To unpair units, touch the check mark icon beside the units.

### Search



Starts searching for pairable sensors.

### Cancel search



Stops searching for pairable sensors.

### Confirm



Exits the Settings and returns to the application.



## FLATNESS MEASUREMENT

### INTRODUCTION

In the Flatness Measurement app, a laser plane is used as a reference. The deviation in distance between the laser plane and the measurement object is measured in one or more positions using the sensor.

The laser plane can either be created by three reference points or by levelling, with the laser plane in level and with one measurement point as reference.

### STARTING

Turn on the sensor and the laser transmitter.

Turn on the tablet.



Flatness app.

Go to settings for connecting the sensor if it is not already connected.

The Flatness Measurement app works with the sensor M9.



Settings.

Settings are described at the end of the chapter.

## MOUNTING

Mount the sensor to the magnetic base, as in picture.



Note: Make sure that the sensor is locked in its position.

## CONFIGURATION

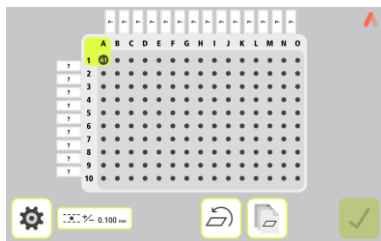

Up to 15 x 10 points can be measured.

Number of points is selected by entering distances between them, starting from point A1.

Equal distances can be entered by entering them at the last point (the farthest from point A1). The same distance will then be filled in all empty boxes towards point A1.

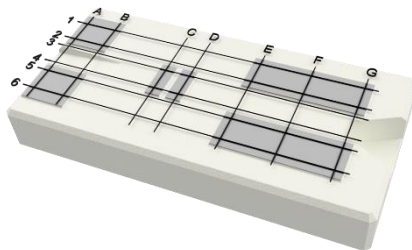

Select an existing measurement object from the flatness measurement list or select to enter distances and tolerances for a new measurement object.

## Flatness measurement list



Opens the flatness measurement list.

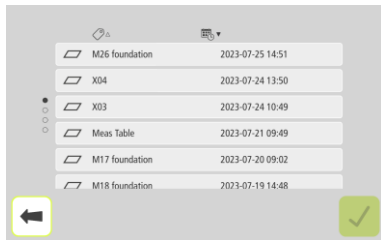

Saved configurations and measurements are available in the flatness measurement list.



Select a measurement object and confirm to open it.

## Enter distances

Measure and enter distances between measurements points.



Opens window for entering distances.

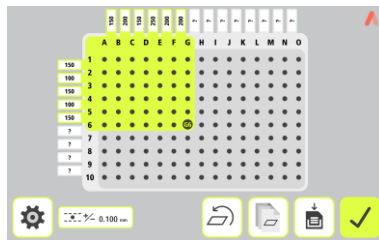

The selected area is marked green.

## Tolerance



Opens window for selection of tolerance.



### Confirm configuration



Confirms the configuration and continues to summary screen.

### Save configuration

The configuration can be saved separately, to be opened up later.



Touch the save icon to save the configuration.

### Change configuration

Distances can be changed.



Opens window for changing distances.

The last distance in the row or column can be deleted if there are no measured points beyond them.



Touch the delete icon to remove a distance.

### Restart



Deletes all entered data and restarts the app.

## COARSE ADJUSTMENT

### Three reference points

1. Position the laser transmitter at one end of the measurement object, on the object or on a tripod.
2. Mark the measurement points and name them as they will be shown in the Flatness app (A1, A2 etc).
3. Position the sensor as close as possible to the laser transmitter. Adjust the height of the laser transmitter and the sensor until the laser beam hits the centre of the target.
4. Move the receiver to a second point on the measurement object far from the transmitter. Adjust the angle of the laser beam, with one of the adjustment screws, until it hits the centre of the target.
5. Move the sensor to a third point on the measurement object in a direction perpendicular to the other two points far from the transmitter. Adjust the angle of the laser beam, with the second adjustment screw, until it hits the centre of the target.
6. Repeat the procedure until the laser beam hits the centre of the target at all three points. Check that the beam falls into the target centre at all measurement points before starting the flatness measurement.

## One reference point – Levelling

To check how a surface is positioned to level, it is necessary to set the laser plane in level. This is done by zeroing the levels with the micrometer screws.



## MEASUREMENT

### Summary screen

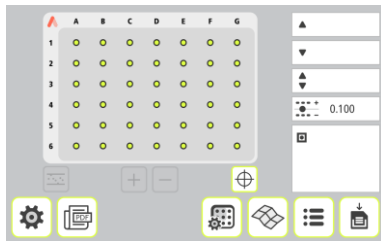

The summary screen shows all the measurement points.

The measurement point registration is done in the measurement point screen.



Touch and release a point to open the measurement point screen.

## Measurement point registration

Place the sensor on the point to be measured.  
Make sure that the laser beam hits the target.

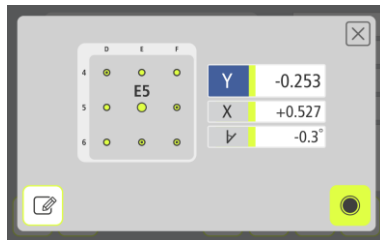
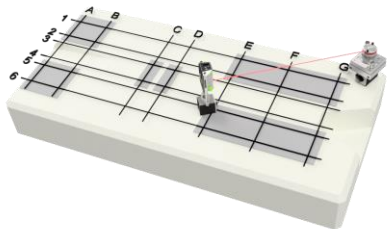

Live values are indicated with a green vertical line beside the values.



Touch the measurement icon to measure the point.

The color indicates the status of the Y value in relation to the selected tolerance.



Within tolerance.



Positive value within double tolerance.



Negative value within double tolerance.



Positive value out of double tolerance.



Negative value out of double tolerance.

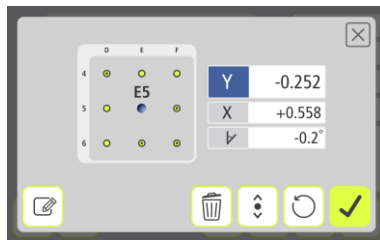

When a measurement point is registered, fixed values are indicated without a green vertical line beside the values.

## Note

A note with up to 20 characters can be entered at each point.



Opens window for entering a note.

## Neighbor points

It is possible to navigate to neighbor points in the measurement point screen.

Touch a neighbor point to go to it.



Unmeasured neighbor point.



Measured neighbor point.

## Remeasure a point



Touch the remeasure icon.

## Delete a point



Touch the delete icon.

## Return to summary screen



Touch the confirmation icon to return to summary screen.

## REFERENCES

There are different ways to select references.

### Manually selected reference points

One or three points can be selected in the measurement point screen.



Select point as reference.

### Reference points for positive values only

When selecting positive values only, suitable reference points are automatically selected. Can be selected in the the summary screen. Use only after points has been measured.



Select references for positive values only.

### Reference points for negative values only

When selecting negative values only, suitable reference points are automatically selected. Can be selected in the the summary screen. Use only after points have been measured.



Select references for negative values only.

### Best fit

The best fit function calculates a reference plane that minimizes the deviation from measured points. A minimum of three measured points is required for the function to be accessible. It is also required that not all the measured points lie on a straight line.

When best fit is enabled, it will continuously recalculate a reference plane whenever the input parameters to the function are changed. These parameters are changed if a new point



is measured, a point is removed or if a distance is changed. The best fit reference plane will however not be recalculated if a measurement point is aligned.



Enable the best fit function.



Update best fit calculations.



Disable the best fit function.

## MEASUREMENT RESULT

### Summary screen

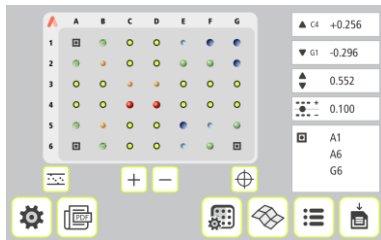

The symbols indicate the status of the measured points.



Within tolerance.



Positive value within double tolerance.



Negative value within double tolerance.



Positive value out of double tolerance.



Negative value out of double tolerance.



Unmeasured point.



Reference point.



Inactive reference point.

Tolerance, maximum and minimum values and the difference between the maximum values are also shown.

Measurement values for each point can be seen in the measurement point screen or in the list. The result is also shown on a 3D screen. It is possible to go back to the configuration screen for changing distances and tolerance.



Touch and release a point to open the measurement point screen.



Touch the list icon to go to the list screen.



Touch the 3D icon to go to the 3D screen.



Touch the configuration icon to go back to the configuration.

## Save measurement

The measurement can be saved anytime and be opened later.



Touch the save icon to save the measurement.

## List screen

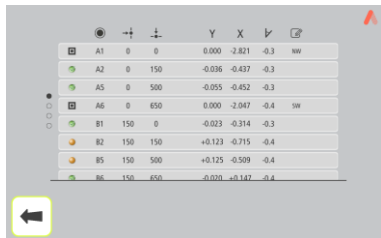

The screenshot shows a list of measurement points. At the top, there are icons for search, zoom, and other functions. The table below lists points A1 through B6. A yellow box highlights a back arrow icon in the bottom left corner of the screen.

			Y	X		
A1	0	0	0.000	-2.821	-0.3	nw
A2	0	150	-0.036	-0.437	-0.3	
A5	0	500	-0.055	-0.452	-0.3	
A6	0	650	0.000	-2.047	-0.4	sw
B1	150	0	-0.023	-0.314	-0.3	
B2	150	150	+0.123	-0.715	-0.4	
B5	150	500	+0.125	-0.509	-0.4	
B6	150	650	-0.020	+0.147	-0.4	

The list screen shows all the measurement points in a list with distances, measurement values and notes if any.

The list is scrollable.



Return to the summary screen.

### 3D screen

The 3D screen can be shown as separate staples at each point or as a continuous surface.



Show 3D screen with staples.



Show 3D screen with a continuous surface.

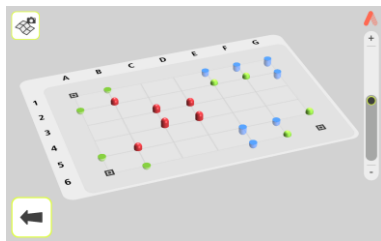

3D screen with staples.

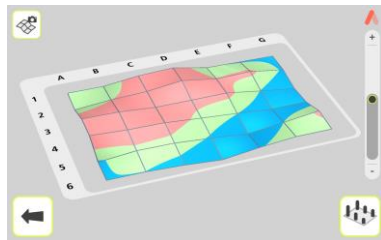

3D screen with a continuous surface.  
Available when all points are measured.



Save a screen shot of the 3D screen.



Return to the summary screen.

## **Evaluating the result**

The result is presented in relation to the selected references. Y values show the deviation from the references, positive values mean that the measurement object at this point is higher than the reference plane and negative values that the measurement object is lower than the reference plane.

These values are compared with the selected tolerance to determine whether correction is necessary. The symbols indicate if the values are within tolerance or not.

## ALIGNMENT

Select the point to be aligned in the measurement point screen.

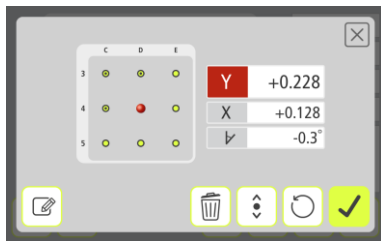

Place the receiver on the point. Make sure that the laser beam hits the target.

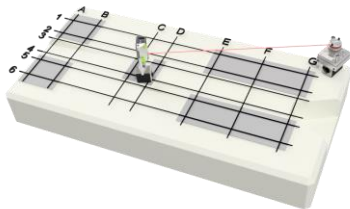

Touch the alignment icon.

Note: Make sure that the receiver is placed in the correct position on the right point before confirming to go to live adjustment.

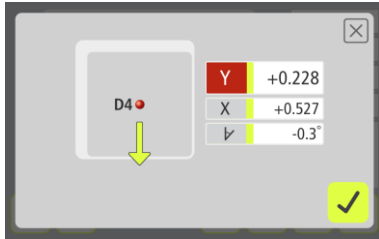

Note: Depending on your measurement object, alignment at one point might affect other measurement points. It is therefore recommended to remeasure all points when adjustments are made.

The actual Y value for the selected point goes live and alignment can be made.

Adjust vertically until the Y value is within tolerance. The arrow shows in which direction to adjust.



Confirm the alignment.



## SENSOR DISPLAY

Sensor Display is reached from the summary screen.



Starts Sensor Display.



Raw sensor values (Y, X and rotational angle) are shown, together with an illustration of the sensor where a red dot is showing the laser hit at the detector.

## SETTINGS

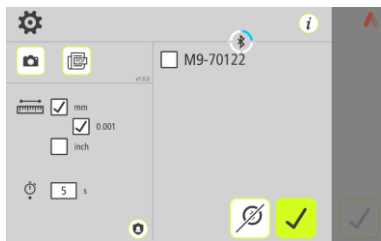

### Info



Touch the Info icon to go to website for downloading user manual.

### Photo



Touch the Photo icon to take a photo.

### PDF report



Touch the PDF icon to create a PDF report.

### Measurement unit



Select mm or inch.

### Best resolution

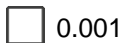

Select 0.001 mm or 0.01 mils.

### Sampling time



Touch the white box to enter sampling time.

## Privacy policy



Touch the Privacy Policy icon to go to website for information about privacy policy.

## Bluetooth settings

When entering settings, the system starts searching for pair able sensors.

Only ACOEM sensors that are switched on will be discovered.



Pair able sensors will appear in the list.



Select the sensor to pair.

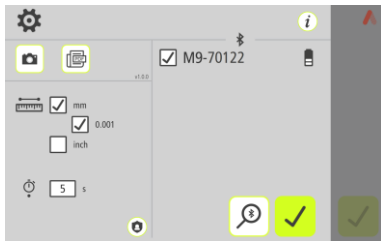

Paired unit is marked with a check mark.

If there is a unit paired to the app, it must be unpaired before it is possible to pair a new unit.



To unpair a unit, touch the check mark icon beside the unit.

### Search



Starts searching for pairable sensors.

### Cancel search



Stops searching for pairable sensors.

### Confirm



Exits the Settings and returns to the application.

## SENSORS M7 AND S7



Sensors with 1-axis detector, inclinometer and laser transmitter.

1. ON/OFF button with status indication LED
  - a. Continuously green – On
  - b. Switching green/red – Gyro activated.
2. Mini USB for charging
3. Laser transmission indication LED
  - a. Green – laser transmission
4. Bluetooth indication LED
  - a. Continuously blue – paired and ready.
  - b. Flashing blue – searching/ready to pair
  - c. No light – Bluetooth disabled.



5. Battery status button – press to instantly show the battery status (also works when the unit is switched off).

6. Battery status LED
- a. One LED continuously red – less than 10% charge left.
  - b. One LED flashing red – less than 5% charge left.
  - c. One LED continuously orange – charging
  - d. One LED continuously green – fully charged.
7. Battery status LED when battery button is pressed
- a. Continuously green – battery status
  - b. Rolling green – battery charging

## **OPERATING MODES**

Turn the units on and off by pressing the ON/OFF button firmly.

In case the units fail to respond, it is possible to turn it off by pressing down the ON button for more than 10 seconds.

## **CONNECTIONS**

### **Bluetooth connection**

The M7 and S7 units are connected by the built in Bluetooth connection. The units will automatically connect to the app when turned on if they are paired. See chapters about apps for instructions on how to pair measurement units.

To avoid accidental Bluetooth transmission in a restricted area the Bluetooth function can be completely disabled – contact your local sales representative for more information.

If the Bluetooth has been disabled (as indicated by the fact that the Bluetooth LED is not flashing or continuously blue when the unit is turned on) it can be enabled by pressing the battery status button quickly 5 times in a row.

## **POWER SUPPLY**

The M7 and S7 units are powered by a high-capacity rechargeable Li-Ion cell, or by the external power unit.

The operating time of the batteries is approximately 11 hours when the system is used for typical alignment work (continuously on).

The M7 and S7 units can be charged with the supplied charger.

When the external power supply is connected, the unit will automatically start charging the batteries. This will be indicated by the first battery status LED turning orange, when the unit is fully charged the LED will turn green. By pressing the battery status button, the exact charging status can be monitored.

The charging time is approximately 8 hours for fully drained batteries. The charging time will be longer if the unit is turned on while being charged.

10.4

When used in typical conditions the batteries will sustain good capacity for approximately 2-3 years before needing replacement. Contact your sales representative for battery replacement.

The batteries contain safety circuitry to operate safely with the unit. The unit can therefore only be used with the Li-Ion batteries supplied by ACOEM. Improper replacement of batteries can cause damage and risk for personal injury. Please refer to the chapter on safety for further instructions.



## SENSORS M10 AND S10



Sensors with 1-axis detector, inclinometer and laser transmitter.

M10 and S10 work as M7 and S7 with the following additions.

The detector is a 3<sup>rd</sup> generation digital sensor.

The measurement distance is 15 meters.

The operating time of the batteries is approximately 20 hours when the system is used for typical alignment work (continuously on).

**10**

M10 and S10 open additional functions in the apps, marked with Sensor 10 symbol.



## SENSORS M9 AND S9

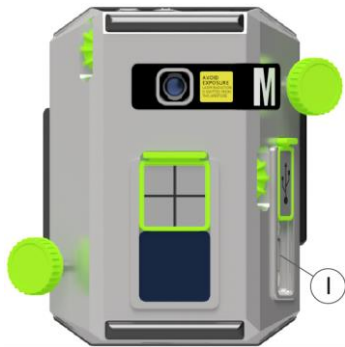

Sensors with 2-axes detector, inclinometer and laser transmitter.

**9**

M9 and S9 open additional functions in the apps, marked with Sensor 9 symbol.

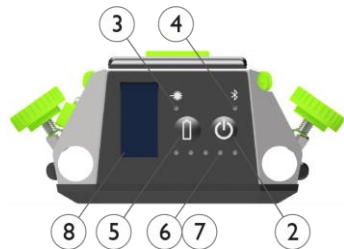

1. Mini USB for charging
2. ON/OFF button with status indication LED
  - a. Continuously green – On
  - b. Switching green/red – Gyro activated.
3. Laser transmission indication LED
  - a. Green – laser transmission

4. Bluetooth indication LED
  - a. Continuously blue – paired and ready.
  - b. Flashing blue – searching/ready to pair
  - c. No light – Bluetooth disabled.
  
5. Battery status button – press to instantly show the battery status (also works when the unit is switched off).
  
6. Battery status LED
  - a. One LED continuously red – less than 10% charge left.
  - b. One LED flashing red – less than 5% charge left.
  - c. One LED continuously orange – charging
  - d. One LED continuously green – fully charged.
  
7. Battery status LED when battery button is pressed.
  - a. Continuously green – battery status
  - b. Rolling green – battery charging
  
8. Display
  - a. Rotational angle.



## **OPERATING MODES**

Turn the units on and off by pressing the ON/OFF button firmly.

In case the units fail to respond, it is possible to turn it off by pressing down the ON button for more than 10 seconds.

## **CONNECTIONS**

### **Bluetooth connection**

The M9 and S9 units are connected by the built in Bluetooth connection. The units will automatically connect to the app when turned on if they are paired. See chapters about apps for instructions on how to pair measurement units.

To avoid accidental Bluetooth transmission in a restricted area the Bluetooth function can be completely disabled – contact your local sales representative for more information.

If the Bluetooth has been disabled (as indicated by the fact that the Bluetooth LED is not flashing or continuously blue when the unit is turned on) it can be enabled by pressing the battery status button quickly 5 times in a row.

## **POWER SUPPLY**

The M9 and S9 units are powered by a high-capacity rechargeable Li-Ion cell, or by the external power unit.

The operating time of the batteries is approximately 8 hours when the system is used for typical alignment work (continuously on).

The M9 and S9 units can be charged with the supplied charger.

When the external power supply is connected, the unit will automatically start charging the batteries. This will be indicated by the first battery status LED turning orange, when the unit is fully charged the LED will turn green. By pressing the battery status button, the exact charging status can be monitored.

The charging time is approximately 8 hours for fully drained batteries. The charging time will be longer if the unit is turned on while being charged.

12.4

When used in typical conditions the batteries will sustain good capacity for approximately 2-3 years before needing replacement. Contact your sales representative for battery replacement.

The batteries contain safety circuitry to operate safely with the unit. The unit can therefore only be used with the Li-Ion batteries supplied by ACOEM. Improper replacement of batteries can cause damage and risk for personal injury. Please refer to the chapter on safety for further instructions.

## LASER ADJUSTMENT

### Height adjustment



### Side adjustment



## LIGHT HOOD EXTENDABLE

Accessory.



Use in low sun.



Use in high sun.



## RUN-OUT PROBE P1



The Run-Out Probe is a battery operated, wireless linear gauge used for measuring run-out on shafts, coupling hubs, flanges and other components used on rotating machinery. It can also be used for distance measurements during adjustments of machinery, soft foot or checks of bearing clearances. The probe is wirelessly connected to the app for registration, display, and

documentation of the measuring results.

1. ON/OFF button
2. Bluetooth indication LED
  - a. Continuously blue – paired and ready.
  - b. Flashing blue – searching/ready to pair
3. Battery status LED
  - a. Continuously red – less than 10% charge left.
  - b. Flashing red – less than 5% charge left.
  - c. Continuously orange – charging
  - d. Continuously green – fully charged.

## **OPERATING MODES**

P1 has two operating modes: On and Off.

Turn the unit on and off by pressing the ON/OFF button firmly.

## **CONNECTIONS**

### **Bluetooth connection**

The P1 unit is connected by the built in Bluetooth connection. The unit will automatically connect to the app when turned on if it is paired. See chapters about apps for instructions on how to pair the Run-Out Probe.

## **POWER SUPPLY**

The P1 unit is powered by a high-capacity rechargeable Li-Ion cell, or by the external power unit.

The operating time of the batteries is approximately 11 hours (continuously on).

The P1 unit is charged with the supplied charger.

When the external power supply is connected, the unit will automatically start charging the batteries. This will be indicated by the battery status LED turning orange, when the unit is fully charged the LED will turn green.

The charging time is approximately 8 hours for fully drained batteries. The charging time will be longer if the unit is turned on while being charged.

When used in typical conditions the batteries will sustain good capacity for approximately 2-3 years before needing replacement. Contact

your sales representative for battery replacement.

The batteries contain safety circuitry to operate safely with the unit. The unit can therefore only be used with the Li-Ion batteries supplied by ACOEM. Improper replacement of batteries can cause damage and risk for personal injury. Please refer to the chapter on safety for further instructions.



## LASER TRANSMITTER T21

Battery powered laser transmitter of diode type. The laser transmitter has a built-in angular prism in a turret allowing a 360° laser plane. Laser beam levelling can be made in the X and Y coordinates as well as parallel adjustments. The turret can easily be detached giving a laser beam perpendicular to the X-Y plane.



## LEVELLING

### Coarse adjustment



Untighten the lock ring

### Fine adjustment



Tighten the lock ring.



## MOUNTING

### Flatness

The T21 can be mounted on a magnetic base or on a tripod.

When using the magnetic base, mount the rod adapter on the magnetic base with the supplied screw. Attach the T21 onto the adapter with the two supplied screw, as shown in picture.



On a tripod, use the supplied screws to attach the T21.

## CALIBRATION OF THE SPIRIT LEVELS

Position the T21 on a table with flat surface which is in level within 0.2 mm/m in both directions. Mark two positions for the receiver minimum 1 meter from each other.

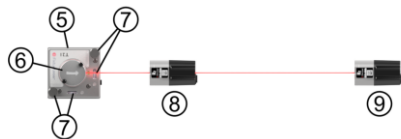
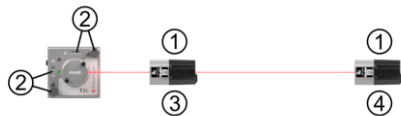

1. Min 1 meter between the detector positions.
2. Zero the levels with the micrometer screws.
3. Zero the value on the screen.
4. Read and note the displayed value.
5. Turn the T21 180°.
6. Turn the turret 180°.
7. Zero the levels with the micrometer screws.
8. Zero the value on the screen.
9. Read and note the displayed value.

The value at 9 should be the same (within 0.2 mm/m) as at 4 if the level for this axis is correctly adjusted. Any difference is divided by two and then added to the lowest of these values, which results in the value R.



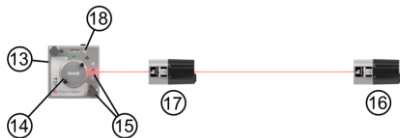
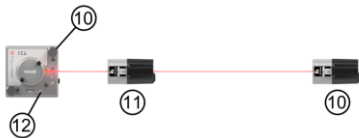

10. Adjust to the R value using the micrometer screws.
11. Check the zeroing, zero again and readjust to R if necessary.
12. Zero the level with the tool.
13. Turn the T21 90°.
14. Turn the turret 90°.
15. Zero the level with the micrometer screws.
16. Adjust to the R value using the micrometer screws.
17. Check the zeroing.
18. Zero the level with the tool.



## ACOEM HOME - LAUNCHER



ACOEM HOME is an easy-to-use launcher.

In ACOEM HOME all available apps are found directly on the home screen. Only run apps approved by ACOEM.



ON/OFF.



Multitasking.

Toggle between apps\* and close apps.



Home.

Goes to Home screen.



Return.

Goes to previous screen.

\*) NOTE: It is not possible to have several apps using the same sensor open at the same time.

## HOME MENU



In the Home Menu you can select the app that you want to use.

In the Home Menu you will also find access to Settings, File Manager and Info.



Settings



File Manager.



Info.



Off.

## SETTINGS

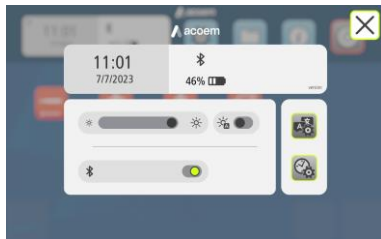

Brightness.



Auto-Brightness, ON/OFF.



Bluetooth, ON/OFF.



Language.



Date and Time.

## FILE MANAGER

### Content in internal memory of the DU

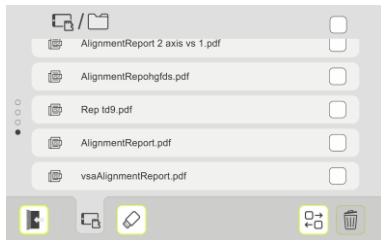

USB flash drive.

Goes to content on USB flash drive.



Transfer files.

Opens file transfer window.

### Content on USB flash drive

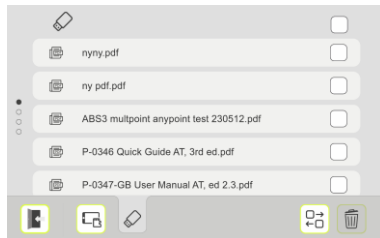

Internal memory.

Goes to content in internal memory.



Transfer files.

Opens file transfer window.

## Transfer files



Select the files to transfer.



Transfer files to USB flash drive.



Transfer files to Display Unit.

## INFO

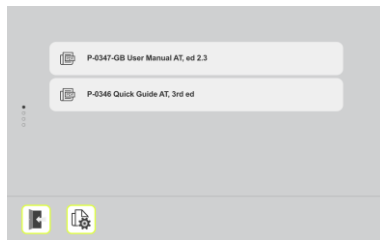

In Info you will find Quick Guides and Manuals.

It is possible to add and remove PDF files.

## OFF

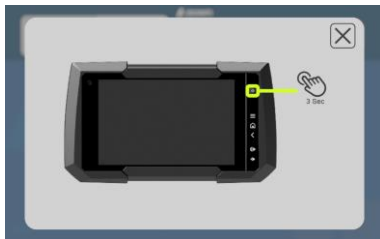

The OFF screen is just a friendly reminder on how to switch off the Display Unit, to avoid draining the batteries while in storage.

## APP UPDATE

Download the desired app update from the ACOEM Alignment Insite web portal, add it to the USB flash drive and transfer it to the internal memory of the ACOEM DU.

Once transferred (this may take some time) you can press the tab for the internal memory and click on the .apk file to start the installation process.



## **ACOEM HOME - FAQ**

### **Q: Can I use the camera on the ACOEM DU?**

A: Yes, the camera can be accessed from all our apps that support the camera.

### **Q: Can I use the FLIR ONE thermal camera on the ACOEM DU?**

A: No, it's not supported.

### **Q: Can I turn on Wi-Fi to download material or send email?**

A: No, the Wi-Fi has been disabled and can't be switched on for any use.

### **Q: Can I upgrade the apps on the ACOEM Home Screen?**

A: Yes, they can be upgraded. The new app installation files known as .apk files will be made available on the ACOEM Alignment Insite web portal. Download the desired app update and transfer it to the internal memory of the ACOEM DU. Once transferred (this may take some time) you can press the tab

for the internal memory and click on the .apk file to start the installation process.

### **Q: Can I install 3rd party apps on the ACOEM DU?**

A: No, only a selection of approved apps supplied by ACOEM can be installed.

### **Q: Can I use the Acoem DU together with the Bearing Defender or the Machine Defender?**

A: No, the Bearing Defender and the Machine Defender are not supported.

### **Q: Can I view or install apk-files directly from the USB stick?**

A: No, files need to be transferred to the internal memory of the ACOEM DU before they can be viewed, accessed, or installed.

### **Q: Can I use a new USB C stick?**

A: The USB stick included has been tested and given permission to be accessed by the system. New USB sticks need to be allowed manually at the first use; this also applies for

USB-sticks from other ACOEM systems. See the screenshots below.



Press 'Use this folder'

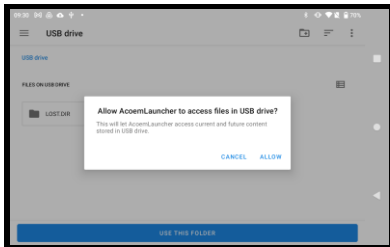

Press 'Allow'

**Q: Can the ACOEM Home be removed from the tablet so I can access all connectivity features?**

A: Yes, the ACOEM Home can be permanently removed. The tablet will then behave and look like a standard Android tablet. This can only be done at ACOEM Sweden at present.

## FLIR ONE 10 9



Thermal imaging camera Flir One Pro-USB-C  
External accessory

### SUPPORT

Flir One Pro-USB-C is compatible with the  
Handheld RT8 - stocked by Acoem AB.

NOTE: Only available on Android.

### APP

Download the Flir One app from Google Play.



Flir One

### INTEGRATION

Possibility to start the Flir One app from inside  
the Horizontal Shaft alignment app.



Touch the IR Photo in Settings  
icon to go to the Flir One app.

Easily add thermal image to alignment report.



Touch the IR Picture icon in  
PDF report to import IR  
pictures.



## TECHNICAL SPECIFICATION – M7 AND S7

Art. No. M7 1-1216, S7 1-1217

Housing Material	Anodized Aluminum frame and high impact ABS plastic over molded with TPE rubber
Operating Temp	-10 to 50°C (14 to 122°F)
Storage Temp	-20 to 70°C (-4 to 158°F)
Long term storage temp	Room temp. 18 to 28°C (64 to 82°F)
Battery Charging temp	0 to 40°C (32 to 104°F)
Relative humidity	10 – 90%
Weight	M7: 212 g (7,5 oz), S7: 186 g (6,6 oz)
Dimensions	92 mm x 77 mm x 33 mm (3,6 in x 3,0 in x 1,3 in)
Environmental protection	IP65 (Dust tight and protected against water jets)
Laser	650 nm class II diode laser
Laser line fan angle	6°
Laser line width (1/e <sup>2</sup> )	1.6 mm
Laser line divergence (full angle)	0.25 mrad
Laser power	< 1 mW
Measurement distance	Up to 10 m
Detector	2nd gen. scientific grade CCD
Detector length	30 mm (1,2 in)

Detector angular subtense	30 mrad/m (3mm/100mm per meter)
Detector resolution	1 $\mu\text{m}$
Measurement accuracy	0,3% $\pm$ 7 $\mu\text{m}$
Signal processing	Digital signal processing with sidespot rejection, edge detection, ambient light elimination and anti-vibration mode
Ambient light protection	Optical filtering and digital ambient light signal elimination
Inclinometer	Dual High Performance MEMS inclinometers
Inclinometer resolution	0,01°
Inclinometer accuracy	$\pm$ 0,2°
Gyroscope	6-Axis MEMS Inertial Motion Sensor with drift compensation and automatic field calibration
Gyroscope accuracy	$\pm$ 1°
Wireless communication	Class I Bluetooth transmitter
Communication range	10 m (33 ft)
Connectors	1 USB Mini port (IP67); Charging: 5V, 0,5A
Power supply	High performance Li Ion battery or external power.
Operating time	11 hours continuous use (measuring)
Battery Charging time (system off, room temperature)	8 h
Battery Capacity	11.5 Wh

---

LED indicators

Unit state, laser transmission and 5 battery status indicators with instant battery check

---

Specifications are subject to change without notice.





## TECHNICAL SPECIFICATION – M10 AND S10

Art. No. M10 1-1263, S10 1-1264

Housing Material	Anodized Aluminum frame and high impact ABS plastic over molded with TPE rubber
Operating Temp	-10 to 50°C (14 to 122°F)
Storage Temp	-20 to 70°C (-4 to 158°F)
Long term storage temp	Room temp. 18 to 28°C (64 to 82°F)
Battery Charging temp	0 to 40°C (32 to 104°F)
Relative humidity	10 – 90%
Weight	M10: 212 g (7,5 oz), S10: 188 g (6,6 oz)
Dimensions	92 mm x 77 mm x 33 mm (3,6 in x 3,0 in x 1,3 in)
Environmental protection	IP65 (Dust tight and protected against water jets)
Laser	650 nm class II diode laser
Laser line fan angle	6°
Laser line width (1/e <sup>2</sup> )	1.6 mm
Laser line divergence (full angle)	0.25 mrad
Laser power	< 1 mW
Measurement distance	Up to 15 m
Detector	3rd gen. digital sensor
Detector length	30 mm (1,2 in)

Detector angular subtense	30 mrad/m (3mm/100mm per meter)
Detector resolution	1 $\mu\text{m}$
Measurement accuracy	0,3% $\pm$ 7 $\mu\text{m}$
Signal processing	Digital signal processing with sidespot rejection, edge detection, ambient light elimination and anti-vibration mode
Ambient light protection	Optical filtering and digital ambient light signal elimination
Inclinometer	Dual High Performance MEMS inclinometers
Inclinometer resolution	0,01°
Inclinometer accuracy	$\pm$ 0,2°
Gyroscope	6-Axis MEMS Inertial Motion Sensor with drift compensation and automatic field calibration
Gyroscope accuracy	$\pm$ 1°
Wireless communication	BLE Bluetooth Low Energy
Communication range	10 m (33 ft)
Connectors	1 USB Mini port (IP67); Charging: 5V, 0,5A
Power supply	High performance Li Ion battery or external power.
Operating time	20 hours continuous use (measuring)
Battery Charging time (system off, room temperature)	8 h
Battery Capacity	11.5 Wh

---

LED indicators

Unit state, laser transmission and 5 battery status indicators with instant battery check

---

Specifications are subject to change without notice.



## TECHNICAL SPECIFICATION – M9 AND S9

Art. No. M9 1-1263, S9 1-1264

Housing Material	Anodized Aluminum frame and high impact ABS plastic
Operating Temp	-10 to 50°C (14 to 122°F)
Storage Temp	-20 to 70°C (-4 to 158°F)
Long term storage temp	Room temp. 18 to 28°C (64 to 82°F)
Battery Charging temp	0 to 40°C (32 to 104°F)
Relative humidity	10 – 90%
Weight	M9: 306 g (10,8 oz), S9: 306 g (10,8 oz)
Dimensions	100 mm x 77 mm x 43 mm (3,9 in x 3,0 in x 1,7 in)
Environmental protection	IP65 (Dust tight and protected against water jets)
Laser	650 nm class II diode laser
Laser power	< 1 mW
Measurement distance	63 mm to 20 m
Detector	2-axis PSD
Detector size	20 mm x 20 mm (0,79 in x 0,79 in)
Detector resolution	1 µm
Measurement accuracy	1% ± 3 µm

Ambient light protection	Optical filtering and digital ambient light signal elimination
Inclinometer	Dual High Performance MEMS inclinometers
Inclinometer resolution	0,01°
Inclinometer accuracy	±0,1°
Gyroscope	6-Axis MEMS Inertial Motion Sensor with drift compensation and automatic field calibration
Gyroscope accuracy	±1°
Wireless communication	BLE Low Energy Bluetooth
Communication range	10 m (33 ft)
Connectors	1 USB Mini port (IP67); Charging: 5V, 0,5A
Power supply	High performance Li Ion battery or external power.
Operating time	8 hours continuous use (measuring)
Battery Charging time (system off, room temperature)	8 h
Battery Capacity	11.5 Wh
LED indicators	Unit state, laser transmission and 5 battery status indicators with instant battery check

Specifications are subject to change without notice.

## TECHNICAL SPECIFICATION – P1

### Art. No. 1-1063

Housing Material	ABS plastic
Operating Temp	0 to 40°C (32 to 104°F)
Storage Temp	-20 to 60°C (-4 to 140°F)
Long term storage temp	Room temp. 18 to 28°C (64 to 82°F)
Battery Charging temp	0 to 40°C (32 to 104°F)
Relative humidity	10 – 90%
Weight	142 g (5.0 oz)
Dimensions battery unit	44 x 91 x 33 mm (1.7 x 3,6 x 1,3 in)
Dimensions pen body	Length: 85 mm (3.34 in) Diameter: Ø 8 mm (Ø 0.31 in)
Length cable	400 mm (15.7 in)
Environmental protection	IP65
Measuring range	5 mm (0.20 in)
Mechanical travel	6.6 mm (0.26 in)
Measuring force	0.70 N ±25%
Repeatability	0.15 µm
Thermal drift	0.25 µm/°C
Accuracy error (K=Reading in mm)	±MAX(5+ 2*K ; 7*K ) µm
Contact type	Ø 3 mm (Ø 0.12 in) carbide

Contact thread	M2.5
Interface	Membrane Switch Keyboard
Wireless communication	Class I Bluetooth transceiver with multi-drop capability. BLE Bluetooth Low Energy (BT 4.0)
Communication range	10 m (33 ft)
Connectors	1 USB Mini micro port Charging: 5V, 0.5A
Power supply	Rechargeable Li Ion battery or external power supply.
Operating time	11 hours continuous use
Battery Charging time (system off, room temperature)	8 h
Battery Capacity	10.4 Wh
LED indicators	Wireless communication and battery status indicators.

Specifications are subject to change without notice.



## TECHNICAL SPECIFICATION – T21

### Art. No. 1-0897

Housing material	Anodized aluminum
Operating temperature	0 to 50°C (32 to 122°F)
Storage temperature	-20 to 70°C (-4 to 158°F)
Relative humidity	10 – 90%
Weight	1150 g (2.54 oz)
Dimensions	100 mm x 103 mm x 109 mm (3.9 in x 4.0 in x 4.2 in)
Laser	650 nm class II diode laser
Laser power	< 1 mW
Measurement distance	Up to 20 m (66 ft)
Laser sweep flatness	±0.02 mm/m
Angular prism accuracy	±0.02 mm/m
Spirit level resolution	0.3 mm/m
Power supply	2 batteries type LR6 (AA)
Warming up time	10 min
Operating time	15 hours

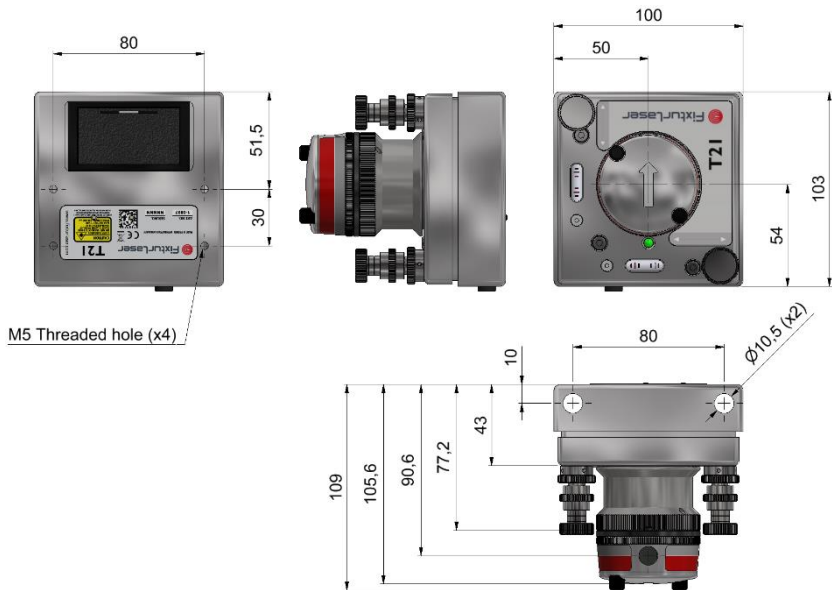





**acoem**

CREATING ENVIRONMENTS OF POSSIBILITY

Publication No. P-0347-GB

© 2023 ACOEM AB, Mölndal, Sweden

All rights reserved. No part of this manual may be copied or reproduced in any form or by any means without prior permission from ACOEM AB

**acoem.com**